

# **Skyline**

**Book Binding Machines & Supplies**

Sales • Service • Repair

Professional Service – Fast Nationwide Shipping

1-866-455-9900

[www.OnlineSkyline.com](http://www.OnlineSkyline.com)   [CustomerService@onlineskyline.com](mailto:CustomerService@onlineskyline.com)

# Mod. 1071 A

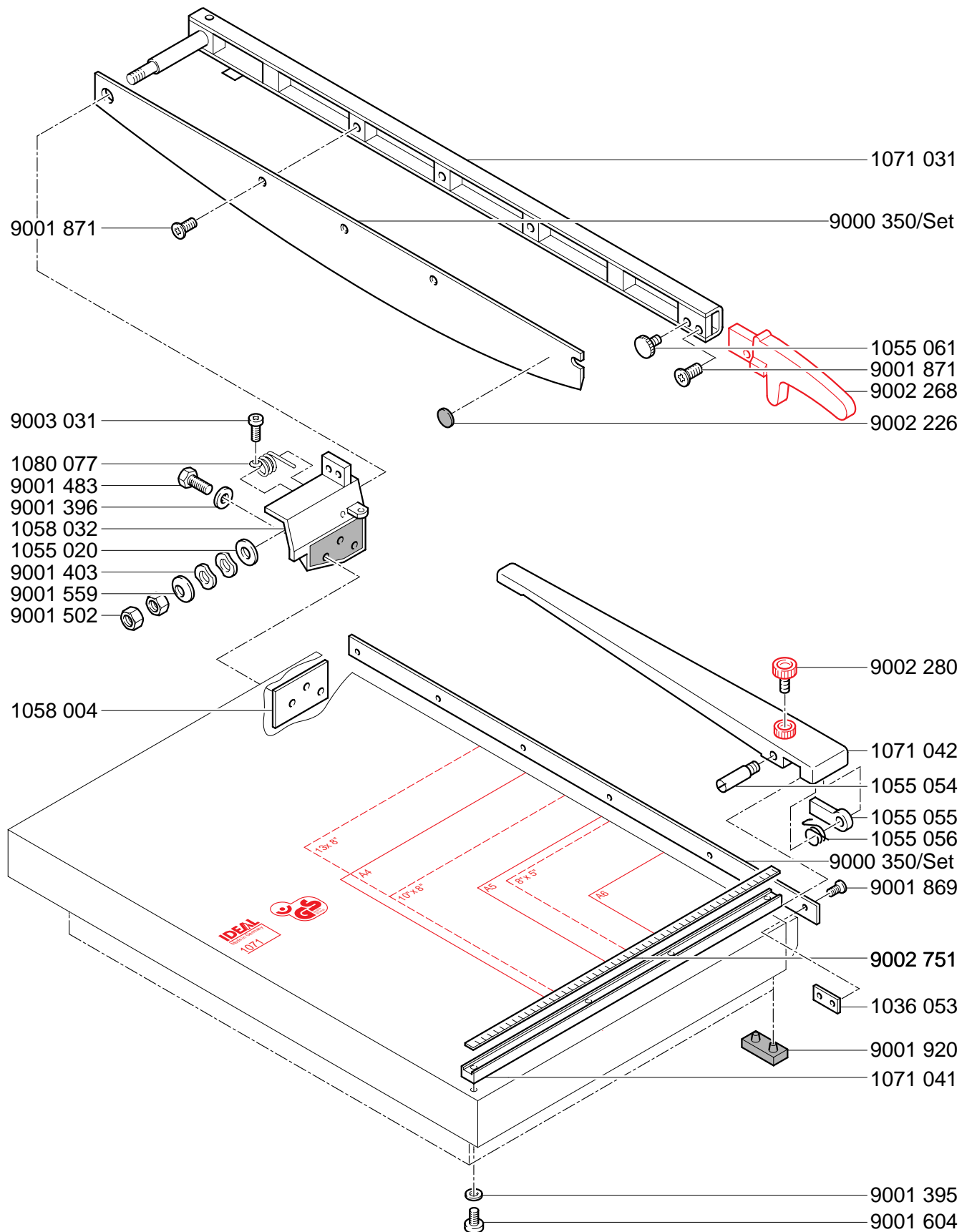

# Mod. 1071 A

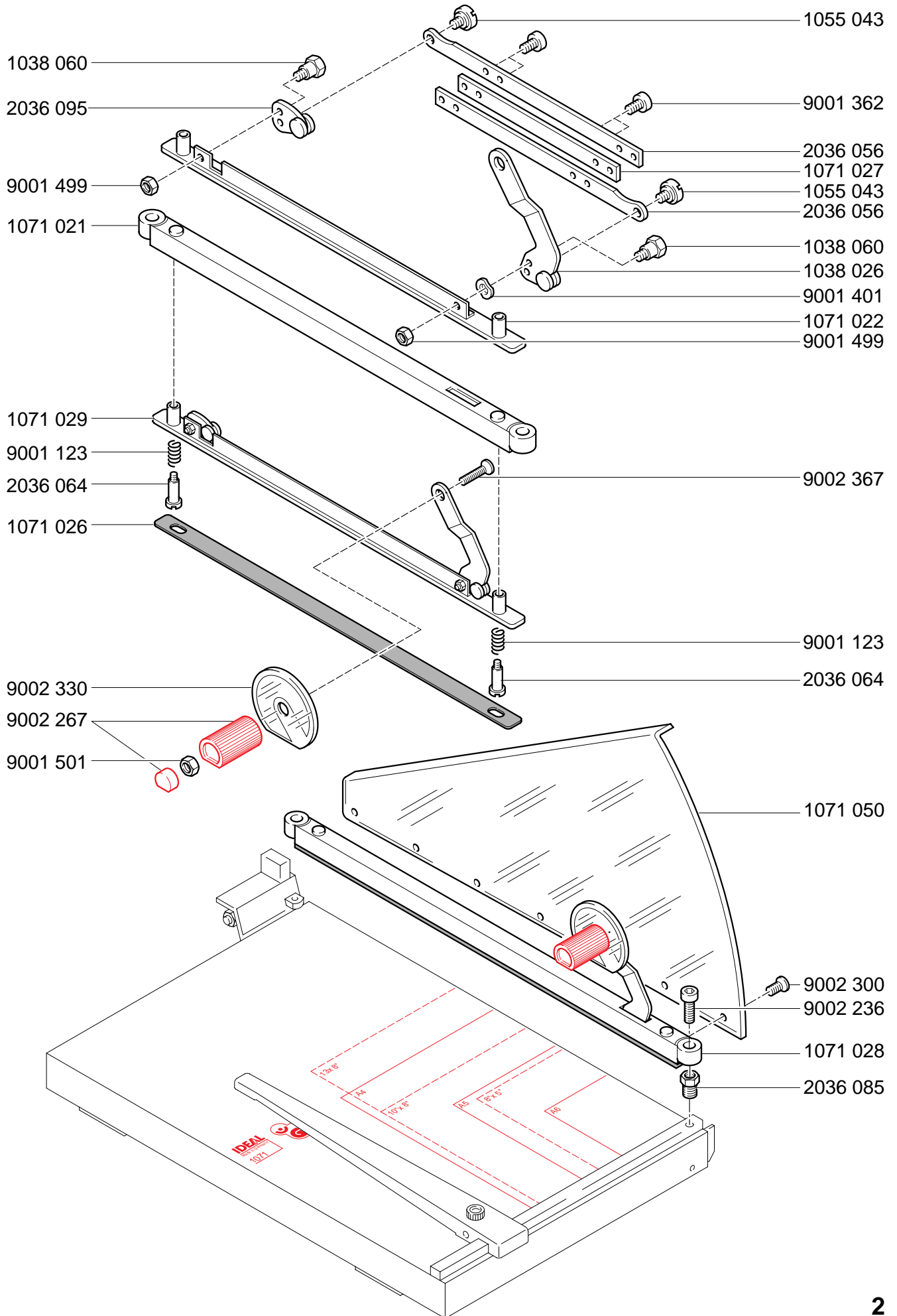

# Mod. 1071 A

