



Skyline

Book Binding Machines & Supplies

Sales • Service • Repair

Professional Service – Fast Nationwide Shipping

1-866-455-9900

www.OnlineSkyline.com CustomerService@onlineskyline.com

OPERATION
MANUAL

VBV
CORPORATION

Stitch**Fold** Trimmer

Trimmer

CONTENTS

Introduction	3
Specifications	3
Safety	4, 5
Installation	6-8
Setup	9
Control Panel	10
Operation	11, 12
Maintenance	13
Adjustments	14
Fuses Access	15
Preventive Maintenance	15
Knife Removal & Installation	16-19
Clearing A Trimming Jam	19
Knife Care Tips	20
Notes	21
Trouble Shooting	22-25

INTRODUCTION

MBM Corporation is proud to introduce another addition to its complete line of equipment for bookletmaking. Now you have the ability to trim books *in-line!* This combination offers you reliability and versatility that improves production and reduces downtime.

Trimmer Features:

- In-line face trimming of booklets
- Jam detection
- Electrical interface for communication with StitchFold Bookletmaking System
- Safety interlock
- See-through top cover

TRIMMER SPECIFICATIONS

Unit Weight:	236 Pounds
Speed:	Up to 2,400 booklets per hour (115Vac machine)
Capacity:	<p>Minimum</p> <p style="padding-left: 40px;">4.00" cut width x 4.13" to fold (trim length)</p> <p style="padding-left: 40px;">2 sheets 20# bond thickness</p> <p>Maximum</p> <p style="padding-left: 40px;">12.71" cut width x 9.00" to fold (trim length)</p> <p style="padding-left: 40px;">50 sheets 20# bond thickness (0.20")</p> <p style="padding-left: 40px;">.625" maximum material trim</p>
Booklets:	<p>4.25" x 5.5", 5.5" x 8.5", 8.5" x 11", 4.75" x 4.75 "CD", & metric sizes</p> <p>(All booklets with or without trim stock on one or three sides)</p>
Output:	Indexing conveyor
Footprint:	16.50" x 18.38"
Dimensions:	<p>Height 27.38" Width 26.42" Length without discharge table 25.90"</p> <p>Length with fully extended discharge table 48.44"</p>
Modes:	Trim or No-trim
Electrical:	<p>Standard outlet - 115 Volts, 60 Hz, 6 Amps (1/4 HP)</p> <p>Optional: 230Vac, 50 Hz, 3 Amps</p>

Trimmer

SAFETY

SAFETY PRECAUTIONS AND PROCEDURES

1. *Make sure electrical power is turned off before performing any adjustment or maintenance.*
2. *Keep hands, hair, tools, and clothing clear of trimming area.*
3. *Become familiar with the moving components of your machine. Keep fingers away from areas that could pinch or cut.*
4. **BE EXTREMELY CAREFUL** when changing the cutter knife. *Severe lacerations or dismemberment could result from careless handling procedures.*
5. **NEVER REACH UNDER THE KNIFE** *Severe lacerations or dismemberment could result.*
6. **NEVER OPERATE THE TRIMMER WITHOUT THE B2000 BOOKLETMAKER AND SAFETY INTERLOCK SYSTEM.**
6. *A well maintained machine is a safer machine. Clean and lubricate the machine at regular intervals. Check machine daily for broken or worn parts. Replace as necessary. DO NOT attempt to operate the machine if a part is broken.*
7. *See "SAFETY GUARDS" below! If you are unsure how to safely operate your trimmer, contact your Service Representative.*



**KEEP HANDS CLEAR OF TRIMMING AREA AND ANY MOVING PARTS!
NEVER OPERATE MACHINE WITHOUT ALL GUARDS IN PLACE!**

SAFETY GUARDS (figs 1 & 2)

- A. Top Cover: Blocks access to mechanism that drives the trimming knife and conveyor belts. An electrical interlock keeps the machine turned off unless this guard is closed. Do not stick your fingers under the top guard!
- B. Front Upper Cover: Blocks access to the trimming knives and the mechanism that drives the upper trimming knife.
- C. Infeed Table Bottom Cover: Blocks access to infeed conveyor belts.
- D. Front Lower Cover: Blocks access to dangerous electric voltage and mechanisms that can pinch or cut. Be sure to disconnect electrical power before removing this cover.
- E. Right Side Cover: Blocks access to low voltage connections and mechanisms that can pinch or cut. Do not stick your fingers beyond this cover!
- F. Rear Upper Cover: Blocks access to dangerous electric voltage and control circuit connections. Be sure to disconnect electrical power before removing this cover.
- G. Rear Lower Cover: Blocks access to low voltage connections and mechanisms that can pinch or cut. Do not stick your fingers beyond this cover!
- H. Left Side Cover: Blocks access to low voltage connections and mechanisms that can pinch or cut. Do not stick your fingers beyond this cover!

SAFETY GUARDS

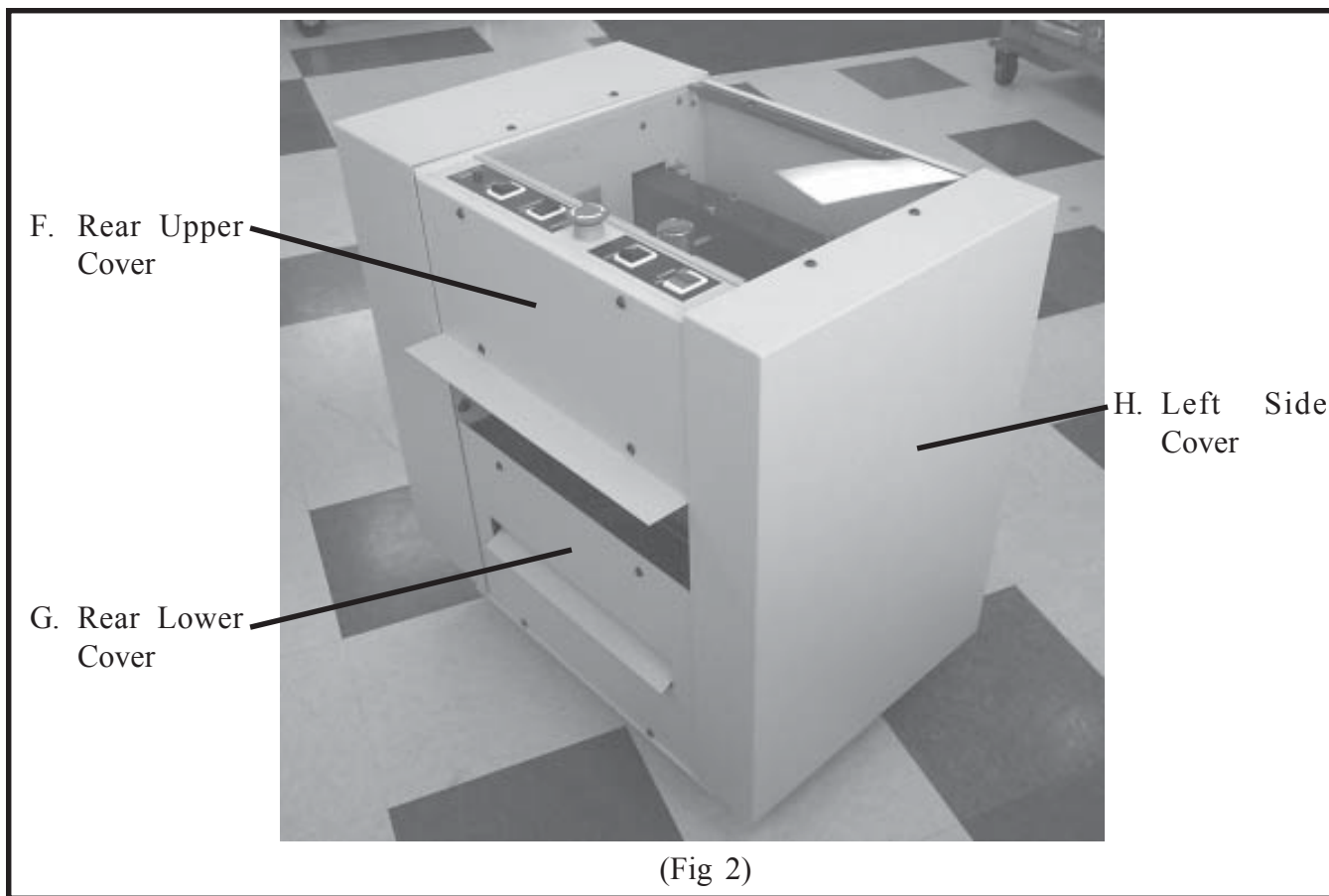
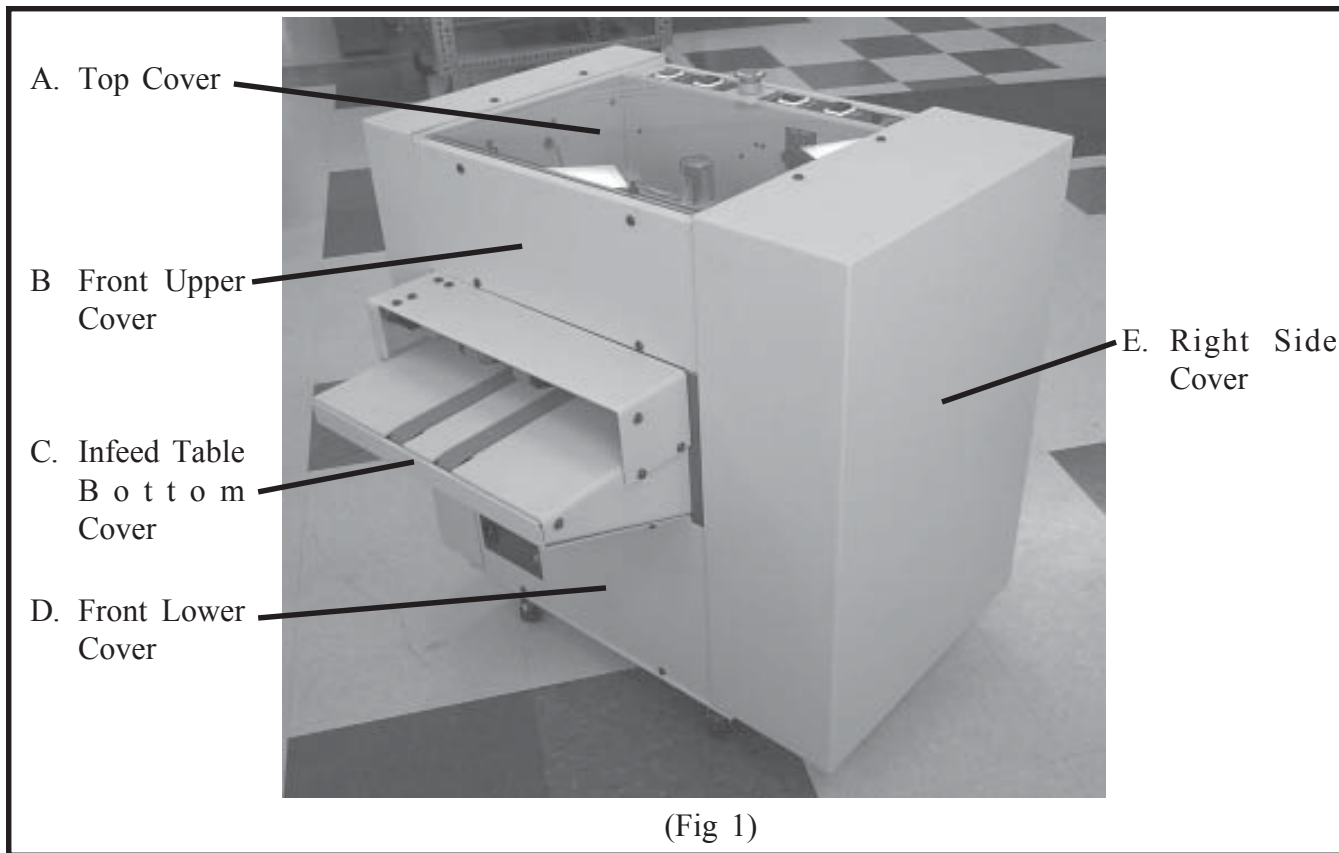

Trimmer

INSTALLATION

BEFORE UNCRATING:

Examine the crate for visible damage. If the crate is damaged, the machine might be damaged. Notify the carrier who delivered the machine.

UNCRATING THE MACHINE:

Carefully remove the machine from its container. Lift the machine by grasping its strong framework. Tugging on cables, covers, or other delicate components could cause damage.

Examine the machine for damages incurred during shipping. Do not install a damaged machine. Notify the carrier immediately, and be sure to get a signed copy of the Carrier Inspector's Report of the damage incurred. Your service representative will assist you in determining the cost of repairs.

ELECTRICAL POWER:

The power cord can be plugged into any 115V, 60 Hz, 1 Phase, 15 Amp circuit. The machine draws less than 6 amps.

SAFETY INTERLOCK SYSTEM:

WARNING
NEVER OPERATE THE TRIMMER
WITHOUT THE B2000
BOOKLETMAKER AND SAFETY
INTERLOCK SYSTEM CONNECTED.

Connect the safety interlock system as follows:

1. Remove the back cover (see fig 3) from the Bookletmaker.
2. Put the bolt through the washer of the safety key assembly and screw the bolt half way into the back cover of the Bookletmaker (see fig 4).
3. Install and securely tighten the nut onto the end of the bolt (see fig 5). The bolt must only be removeable by removing the nut first.
4. Install the back cover onto the Bookletmaker (see fig 5).

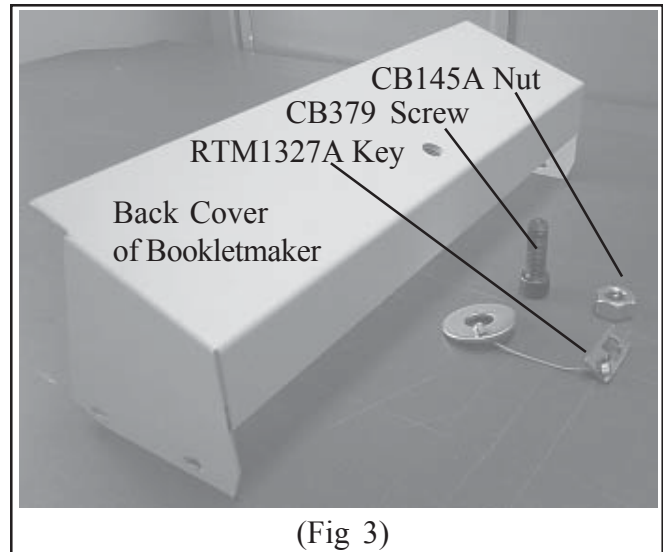

(Fig 3)

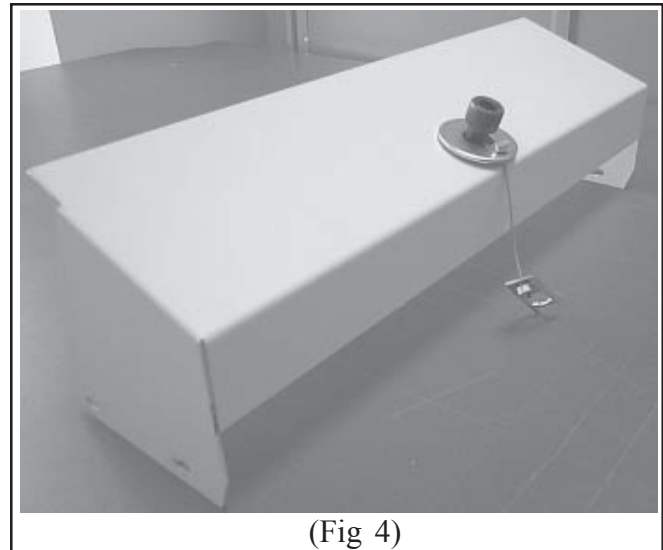

(Fig 4)

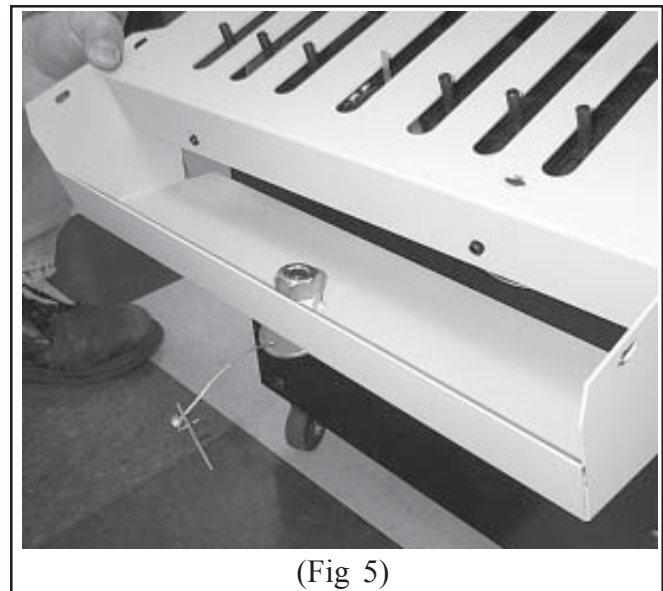

(Fig 5)

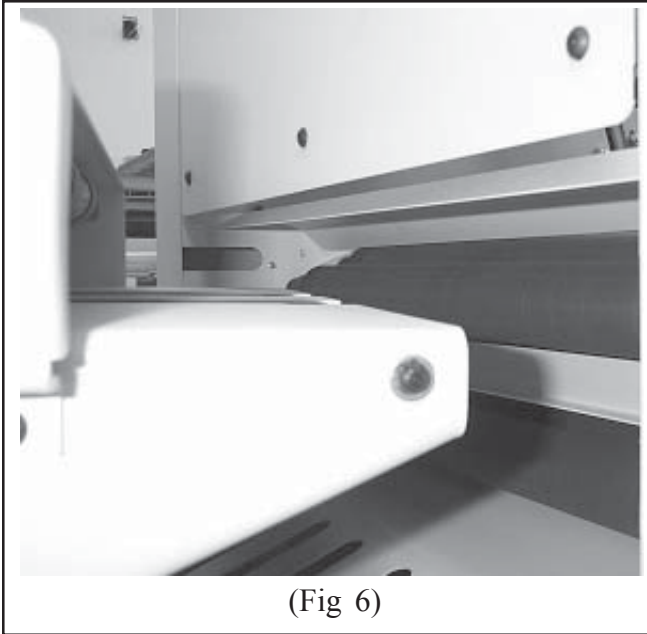

(Fig 6)

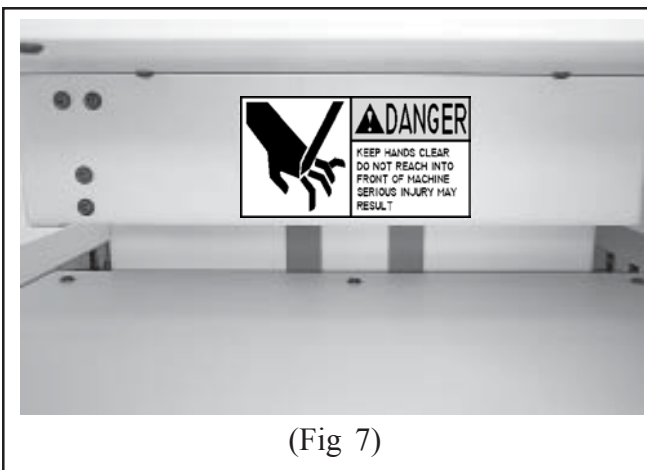

(Fig 7)

TRIMMER TO BOOKLETMAKER CONNECTIONS:

1. Adjust the height of the trimmer so that the top of the trimmer infeed table is about even with the middle of the BookletMakers top discharge roller (see fig 6).
2. Position the trimmer behind the BookletMaker so that the trimmer's infeed table is centered with the BookletMakers discharge, and slightly away from the BookletMaker's top discharge roller (see figs. 7&8).
3. Install the safety interlock key that is hanging from the bottom of the back cover (see fig 9).



(Fig 8)



(Fig 9)

Trimmer

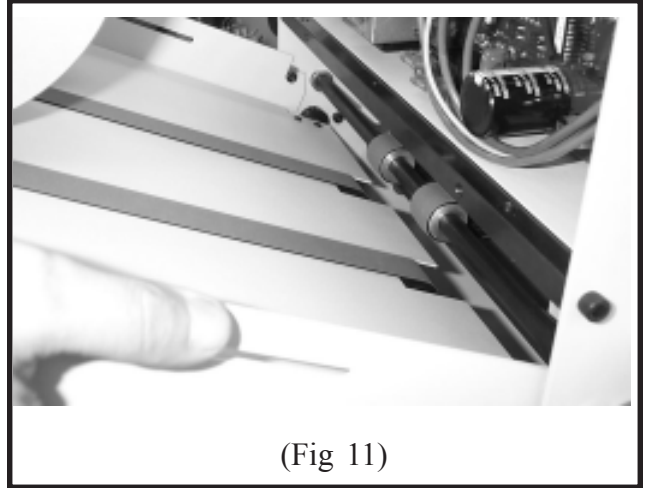
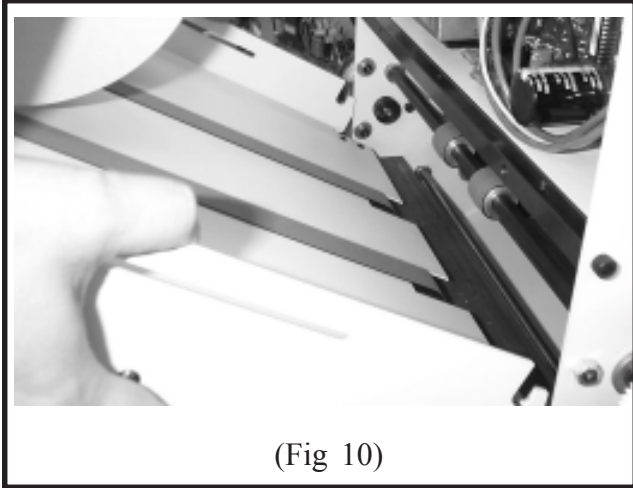

DISCHARGE CONVEYOR TABLE:

Install discharge conveyor table per illustrations (figs 10, 11, & 12).

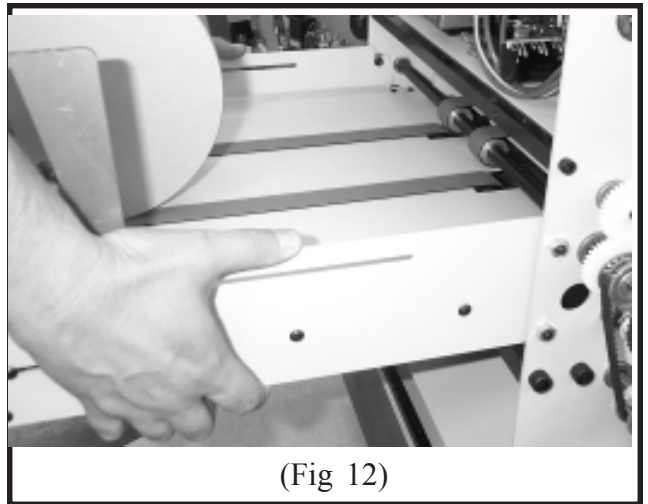

SETUP

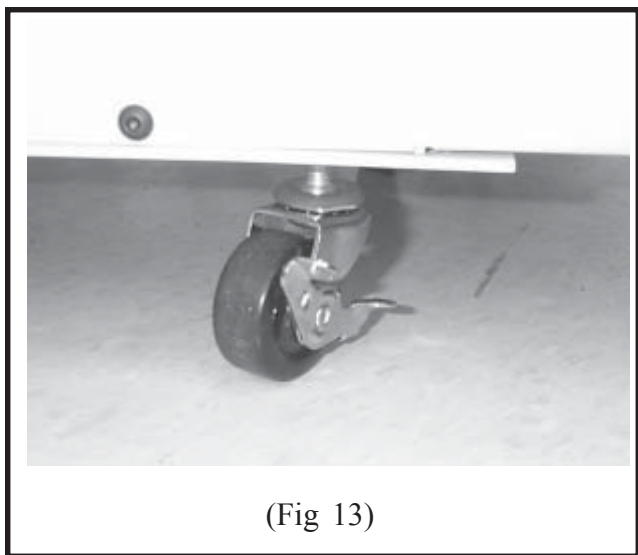

(Fig 13)

TRIMMER HEIGHT:

The height of the trimmer can be adjusted up or down slightly by use of the threaded adjustable casters and locking nuts on the bottom of the trimmer or trimmer stand (fig 13).

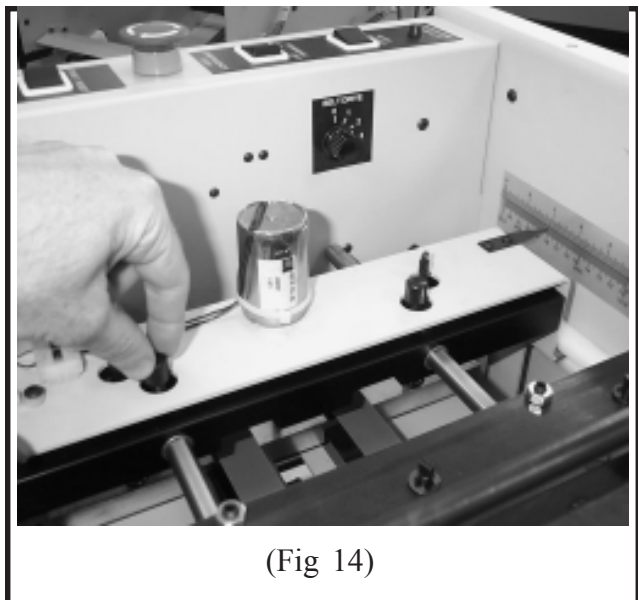

(Fig 14)

TRIM LENGTH:

To set the back stop assembly for the desired trim length, loosen the two thumb screws (fig 14) and slide the back stop assembly forward or back-

ward to the desired location. There is a pointer on the side of the back stop assembly that points to a trim length scale installed on the inside wall of the trimmer. Once located in the desired position tighten the two thumb screws.

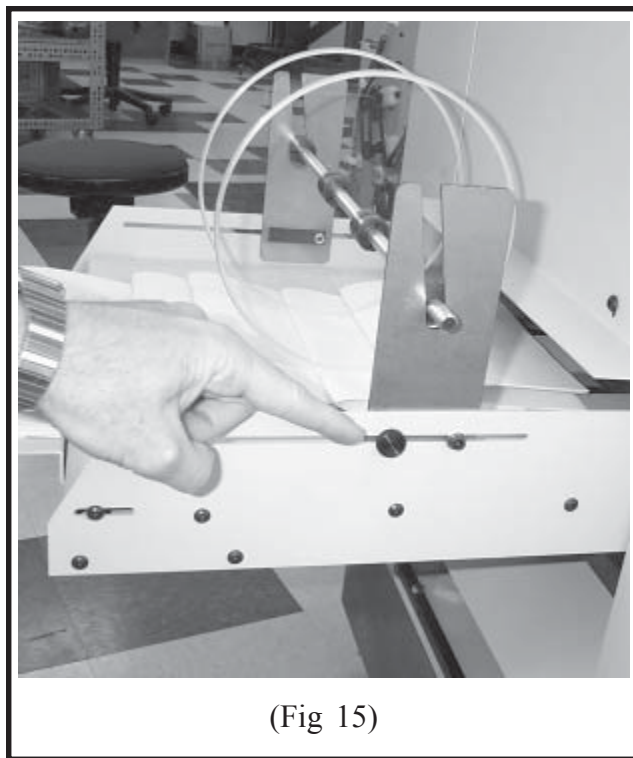

(Fig 15)

DISCHARGE TABLE ROLLERS:

Set the discharge table rollers forward for small booklets or backward for large booklets. To adjust the rollers, loosen thumb screws (fig 15), move roller brackets to desired location, then retighten thumb screws.

Trimmer

CONTROL PANEL (figs. 16 & 17)

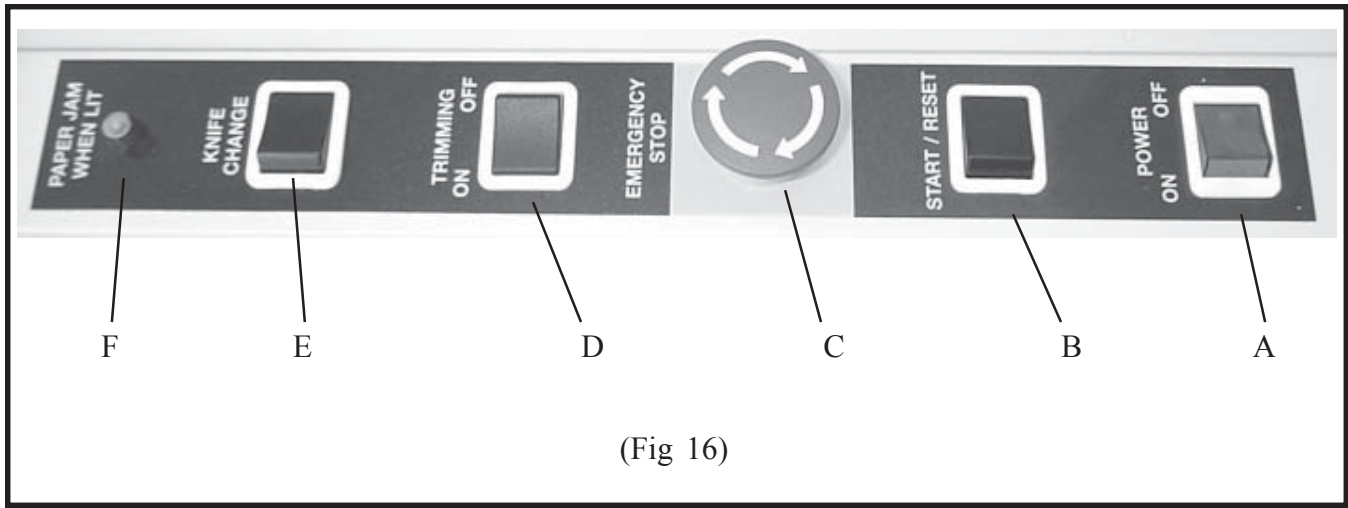

(Fig 16)

A. Power On/Off: Green rocker switch turns on or off power to the machine. Pilot light in switch glows when power is on.

B. Start/Reset: Black rocker switch energizes control circuit, which turns on motor. In addition, the discharge conveyor will run and the work gate will be raised as long as the switch is depressed.

Note: Opening the top guard shuts off the machine. It must be restarted as above.

C. Emergency Stop: Cuts off power to the machine's drive and control circuit when depressed. The Emergency Stop button locks in the down (off) position until manually turned allowing it to pop back up into the power on position. Restart machine per B above.

D. Trimming On/Off: Selector switch chooses mode of operation: "On" for trimming jobs or "Off" to allow work to pass through without trimming.

E. Knife Change: Black rocker cycles the trimming knife up and down as long as it is depressed.

F. Paper Jam When Lit: Glows to indicate that there is a paper jam.

G. Belt Drive: Rotary switch controls when the work conveyor belts shut off after incoming work is sensed. The choice range is 1 through 6. "1" for quick shut off to "6" for maximum extended running of the work conveyor belts after incoming work is sensed.

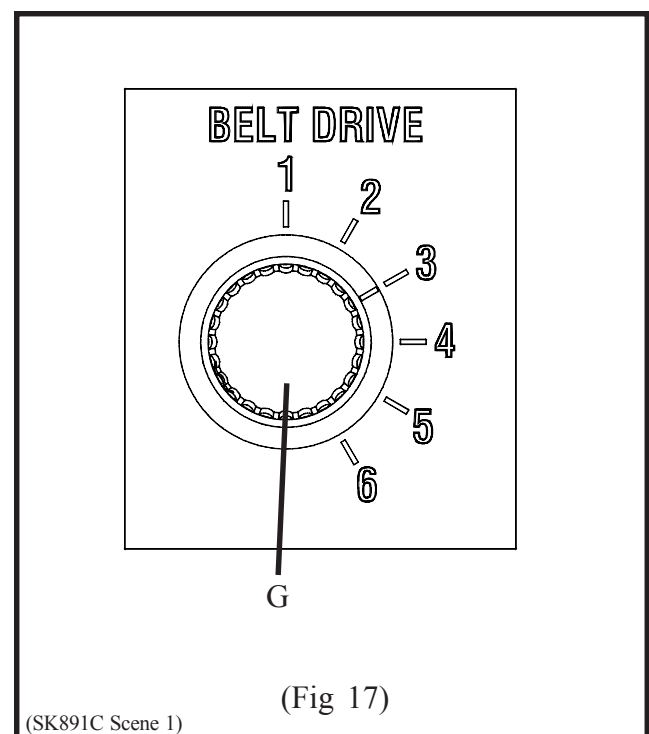

(Fig 17)

(SK891C Scene 1)

OPERATION

STARTUP:

1. The "BELT DRIVE" rotary switch should be set to "1" position.
2. Depress "POWER ON" switch to turn on power.
3. Depress "START/RESET" switch to energize control circuit. The electric motor will now energize and begin the infeed and internal conveyors.
4. Select "TRIMMING ON". Run the Bookletmaker so that a booklet is deposited on the trimmer's infeed table. The booklet will be transported into the trimmer, trimmed, and ejected onto the output conveyor. The output conveyor runs for a short duration each time a booklet is sensed entering the trimmer. This ensures that there is no gap between work on the discharge table.

NORMAL OPERATION:

1. Work is deposited, from the Bookletmaker, onto the trimmer's infeed conveyor table.
2. The infeed conveyor belts pull the work into the trimmer.
3. As the work is pulled into the trimmer, the work passes above photo sensor number one, located at the end of the infeed conveyor table. Number one photo sensor recognizes the work and tells the control circuit that work is entering the machine.
4. The infeed conveyor throws the work over the lower knife area and into the middle work conveyor belts.
5. The middle work conveyor belts pull the work over photo sensor number two, located near the work back stop gate. Number two photo sensor recognizes the work and tells the control circuit that work has entered the trimming area.
6. The control circuit then lets the conveyor belts continue to run, for a short period of time, to allow the work to run into and square up against the back stop gate. The conveyor belts are then stopped.
7. At this time the control circuit energizes the trimming clutch solenoid, which releases the trimming clutch to begin the trimming cycle.

8. The knife bar assembly begins to cycle downward.
9. As the knife bar assembly cycles downward the gate clamp begins to squeeze, flatten, and hold the leading end (or fold) of the work. The front clamp then begins to squeeze, flatten, and hold the trim end of the work.
10. As the knife bar assembly continues downward the knife begins to cut/trim the work.
11. The knife bar then begins cycling back up to the top of its stroke (starting position).
12. As the knife bar approaches the top of its stroke, it passes the knife bar proximity sensor. The proximity sensor tells the control circuit that the knife bar has reached the top of its stroke.
13. The control circuit then deenergizes the trimming clutch solenoid which stops/ends the trimming cycle.
14. The control circuit then energizes the gate solenoid, which lifts up the gate, and energizes the infeed and middle conveyor belts.
15. The trimmed work is then conveyed out of the trimmer and deposited on the discharge table.
16. When the next work to be trimmed is sensed by number one photo sensor (on infeed table) the control circuit energizes the discharge table clutch for a short time. While the discharge clutch is energized it runs the discharge table conveyor belts. The belts move the work on the discharge table a short distance. The control circuit then cuts power to the discharge table clutch. The discharge table conveyor belts and work stop moving until the next piece of work to be trimmed causes the discharge table cycle to repeat.

JAM DETECTION:

If the work does not finish passing over number one photo sensor, within normal operating time, the control circuit recognizes this as a jam. The trimmer drive shuts off. The "PAPER JAM WHEN LIT" indicator light becomes lit. A normally closed relay in the control panel (used as the jam output to another machine or device) closes.

Trimmer



JAM CLEARING & RESTART:

1. Turn off power to the trimmer.
2. Remove work jam. **DO NOT REACH UNDER THE KNIFE! SEVERE LACERATIONS OR DISMEMBERMENT COULD RESULT.**
3. Close all safety covers.
4. Depress "POWER ON" switch to turn on power.
3. Depress "START/RESET" switch to energize control circuit. The electric motor and conveyor clutches will energize so trimming may resume.

JAM OUTPUT:

When a jam occurs a normally closed relay in the control panel closes. This relay is connected to a .141" diameter female phone jack outlet (fig 18) located on the power cord bracket. Any device plugged into the phone jack will receive a closed circuit signal, which that device can use to shut down any upstream machines feeding work to the trimmer.

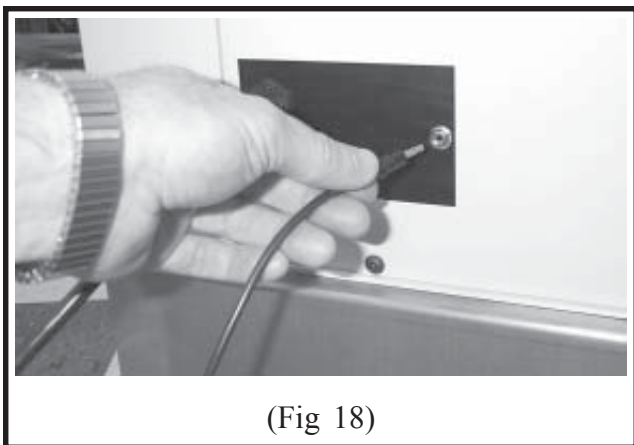

(Fig 18)

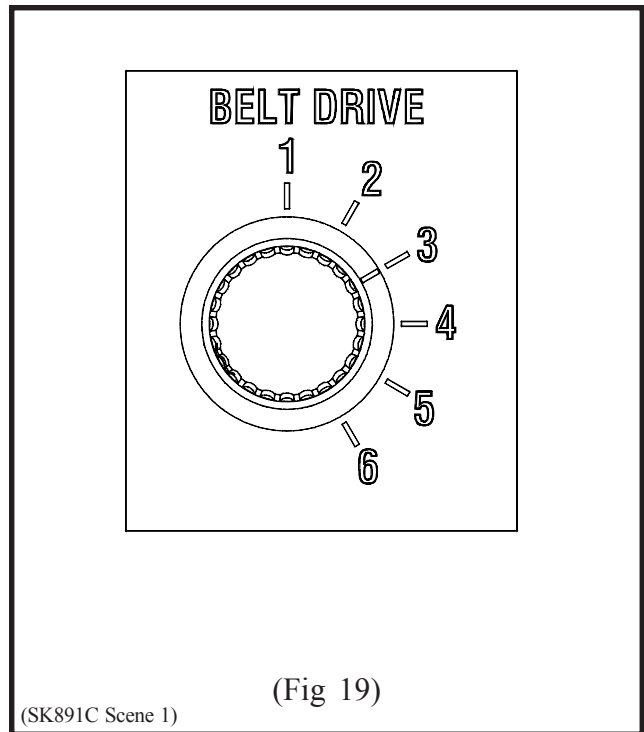

BELT DRIVE:

The purpose of the "BELT DRIVE" rotary switch (fig 19) is to make sure the work will square up against the back stop to provide a good square cut booklet.

The "1" setting means that the internal conveyor belts will shut off quickly after the work is sensed allowing time for the work to square up against the back stop.

If the work does not square up fully against the back stop before being trimmed, rotate the switch to position "2". This position allows the internal conveyor belts to run for an additional short period of time (after the work is sensed) so that the work will square up before being trimmed.

Positions "3" through "6" allow for progressively longer conveyor belt running time for unusual work, such as work that may slip on the conveyor belts, to square up against the back stop.

MAINTENANCE



The instructions on the following pages are for the use of trained personnel only!

Attempting to perform repair and replacement procedures without proper training may cause machine damage or operator injury!

Trimmer

ADJUSTMENTS

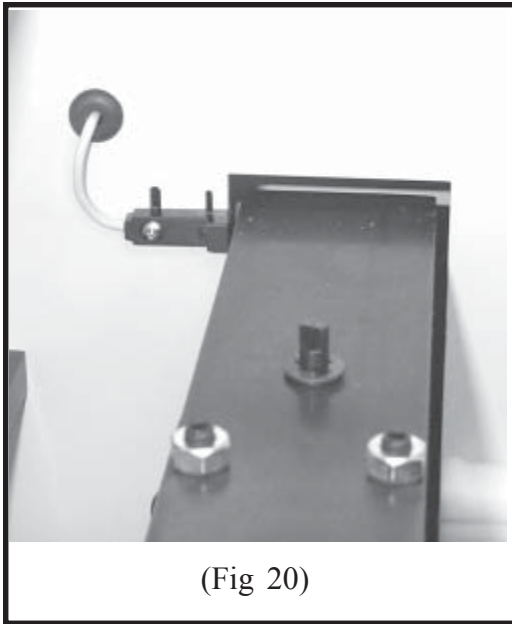

(Fig 20)

KNIFE BAR SENSOR ADJUSTMENT:

The knife bar must always stop at the top of its stroke in order for work to enter the trimmer. If the knife bar stops too low work will not be able to get past the front clamp and/or knife, and work jams will result.

The function of the knife bar sensor is to signal the control circuit when the knife bar has reached the top of its stroke so that the control circuit can denegize the trimming clutch causing the knife bar to stop at the top of its stroke.

1. With power on and drive motor running, use the knife change toggle switch to jog the knife bar to the top of its stroke. If you can not stop the knife bar at exactly the top of its stroke, it is better to stop it slightly before top of stroke rather than after top of stroke.
2. Turn off and unplug power.
3. Remove the left cover.
4. Loosen the screws of the knife bar sensor, move the sensor so that the top of the sensor is even with the top of the knife bar (fig 20).
5. Reinstall the left cover.

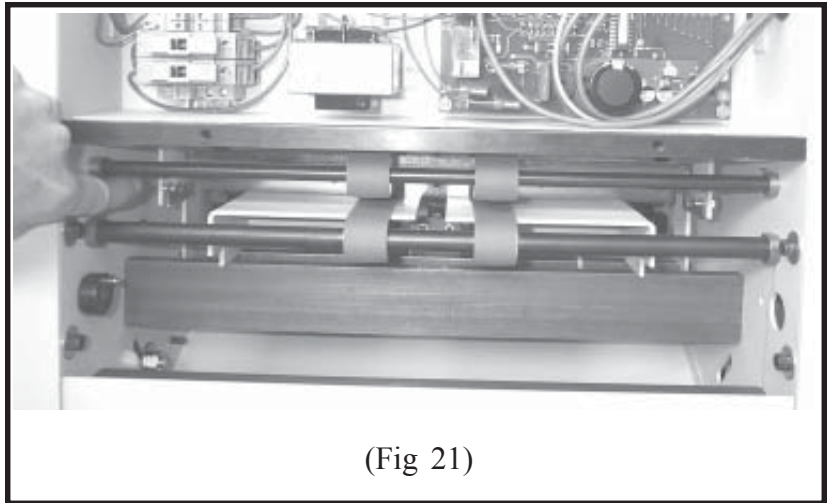

(Fig 21)

BACK STOP GATE ADJUSTMENT:

The function of the back stop gate is to provide a surface for the work to square up against so that the knife will cut the work squarely. The back stop gate must be parallel to the bottom knife.

1. Run several pieces of work through the trim cycle.
2. By looking at the work, determine how much one side or the other of the back stop gate must be moved forward or backward.
3. Turn off and unplug power.
4. Remove rear discharge table.
5. Remove rear upper cover.
6. Open top cover.
7. Slide backgage carriage to front of machine.
8. Using a 3/8" box wrench and a 1/8" hex wrench loosen and shift one of the shoulder screws (fig 21) locating the back stop gate (which will also shift the back stop gate) forward or backward the amount needed to square up the trim. Note: It may be necessary to first move one shoulder screw and then the other in order to obtain the maximum amount of adjustment.
9. Reinstall lower cover and discharge table.

FUSE ACCESS

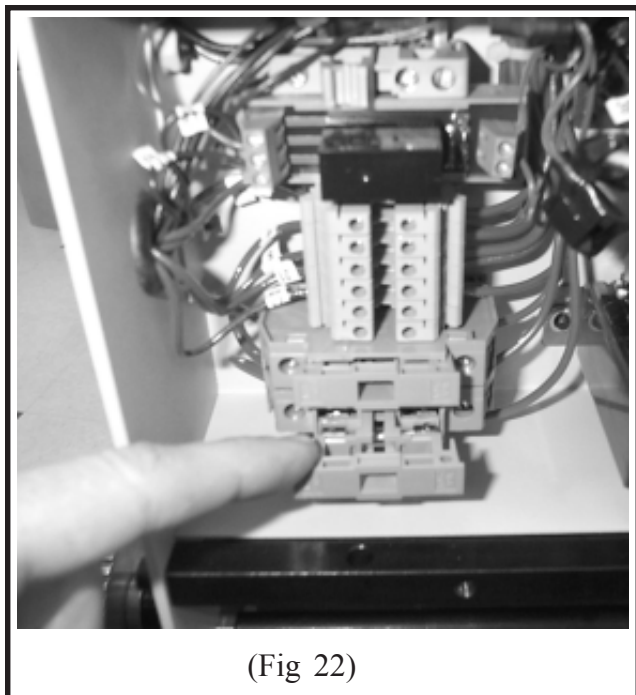

(Fig 22)

Turn power off and unplug the machine. Remove the rear upper cover (removal of four screws required) above the work discharge area of the machine. There are two fuse holders mounted on the din rail. To access the fuses, pull out the fuse compartment (fig 22) of each fuse holder and remove the fuses.

- A. Motor Fuse: Fuse protects the motor input lines of the machine. If this fuse fails, the motor will not run. Replace with 6 amp fuse #RTM1303F for 115Vac machine or 3 amp fuse #RTM1330F for 230Vac machine.
- B. Control Circuit Fuse: Fuse protects transformer. If this fuse fails, none of the 24VDC components will operate. Replace with 1 amp fuse #RTM1302F for 115Vac machine or 0.5 amp fuse #RTM1329F for 230Vac machine.

PREVENTATIVE MAINTENANCE

LUBRICATION:

Disconnect electrical power. Next, remove the front cover and both side covers.

Use SAE-20 oil to lubricate porous bronze bearings, plastic bearings, chains, shafts, and cutter bar linkages.

CLEANING:

Use alcohol to clean the belts.

HARDWARE:

Remove the covers to check all nuts and bolts for tightness. Loose hardware is the cause of most component wear and in the electrical area could cause short circuits and/or shock.

Trimmer

KNIFE REMOVAL & INSTALLATION

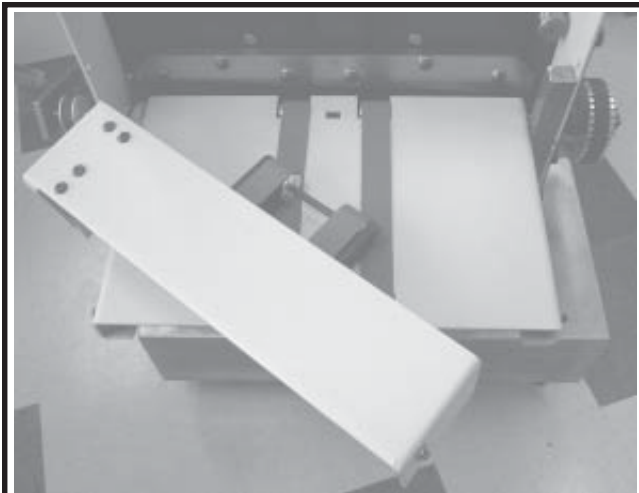

(Fig 23)

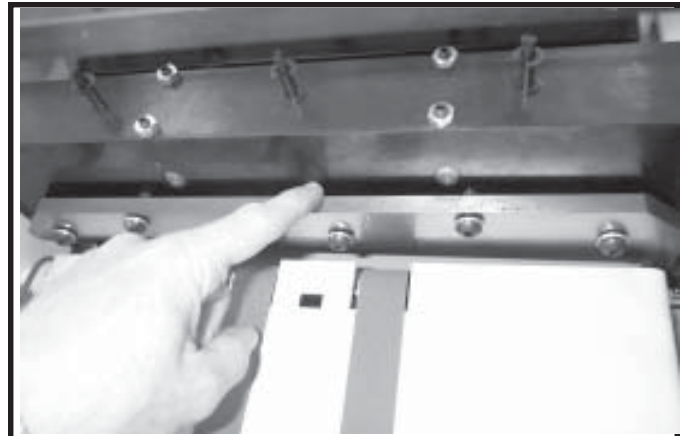

(Fig 24)

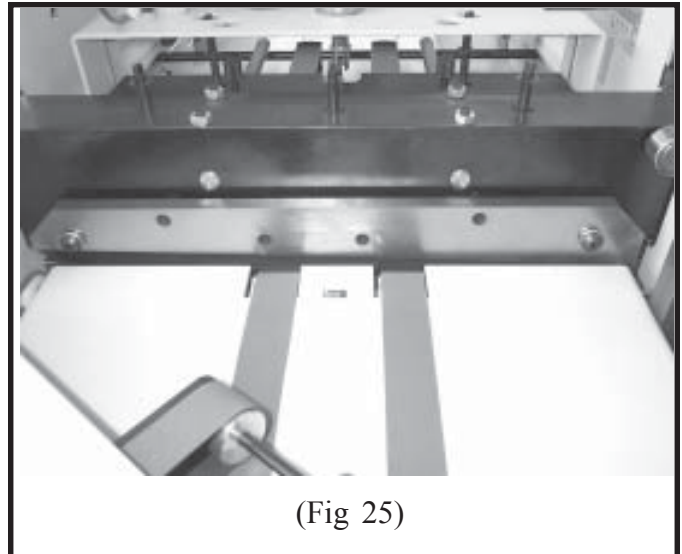

(Fig 25)

UPPER KNIFE REMOVAL & INSTALLATION:

CAUTION: Changing knives can be very dangerous unless safety precautions are observed and extreme care is taken when handling knives

Keep handling of unprotected knives to an absolute minimum.

Warn people of any unprotected knife.

Knife changing is a **ONE PERSON OPERATION**. Having more than one person trying to change knives invites accidents.

1. Use the "Knife Change" rocker switch to move the knife bar to the bottom of it's stroke.
2. Turn off power and unplug power cord.
3. Remove bottom cover of infeed table.
4. Remove front upper cover and the lower bar that the front upper cover attaches to.
5. Remove the left and right side covers.
6. Remove the four screws and nuts holding the top infeed table's conveyor bracket to the infeed table.
7. Carefully lift the right side of the upper infeed conveyor bracket off the infeed table. Swing it out and lay it on the infeed table (fig 23). **NOTE:** Be sure the round belt does not come off pulleys and be sure the separating finger stays between belts where they cross or the infeed table conveyors will not operate properly when reassembled.
8. Loosen, **BUT DO NOT REMOVE**, all upper knife screws so that the upper knife can be slid away from the knife bar on the screws about 1/8 inch (fig 24).
9. Remove only the four middle knife screws so that the two end screws remaining are holding the knife about 1/8 inch away from the knife bar (fig 25).

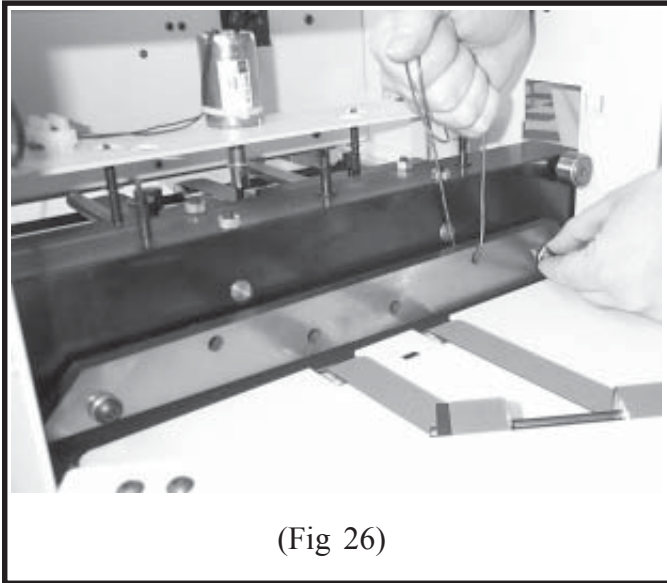

(Fig 26)

10. Insert a strong length of wire through the top right screw hole in the knife. Pull the wire through and securely tie the wire ends to make a strong secure handle that will be used to lift that end of the knife when the right screw is removed (fig 26).

DANGER
 NEVER PUT HAND OR FINGERS
 BELOW KNIFE WHEN REMOVING
 OR INSTALLING. SEVERE LAC-
 ERATIONS OR DISMEMBERMENT
 COULD RESULT.

11. Hold securely onto the wire handle and remove the right knife screw.
12. Use both hands to swing knife up, while pivoting on remaining lower left hand knife screw.
13. While holding knife securely with one hand, remove last knife screw, and remove knife from trimmer (fig 27).
14. Put blade in the scabbard immediately and secure the knife retaining screws.
15. Reverse this procedure to install upper knife.

LOWER KNIFE REMOVAL:

THE UPPER KNIFE MUST BE REMOVED (per steps 1-13 of Upper Knife Removal page 16 & 17) **BEFORE THE LOWER KNIFE IS REMOVED.**

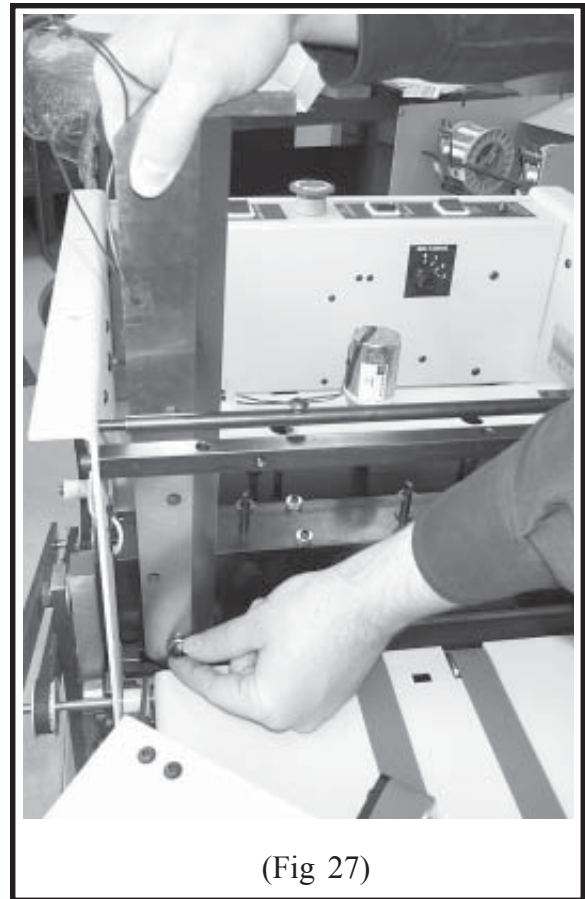

(Fig 27)

CAUTION: Changing knives can be very dangerous unless safety precautions are observed and extreme care is taken when handling knives

Keep handling of unprotected knives to an absolute minimum.

Warn people of any unprotected knife.

Knife changing is a **ONE PERSON OPERATION**. Having more than one person trying to change knives invites accidents.

1. Once the upper knife is removed, cycle the knife bar back up to the top of it's stroke by manually releasing the trim clutch and turning the large pulley on the clutch clockwise (fig 28) until the knife bar is all the way up.
2. Loosen the five screws securing the lower knife (fig 29).
3. Remove the lower knife.

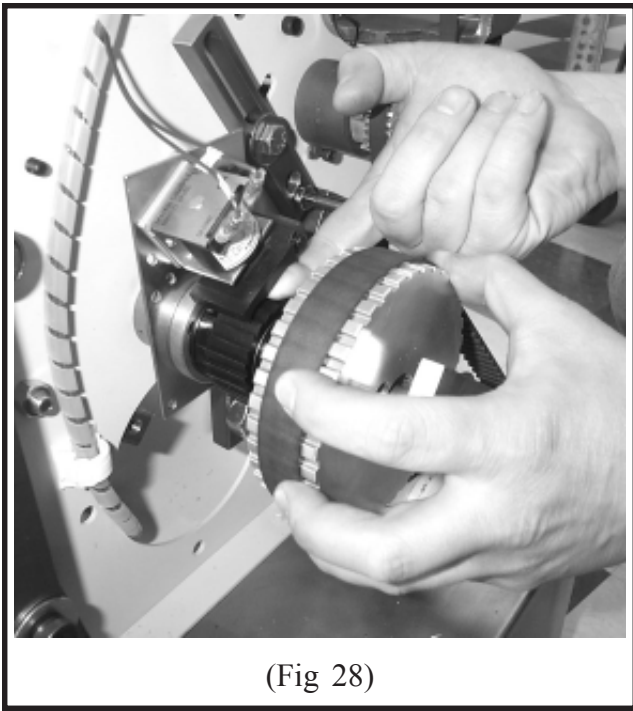

(Fig 28)

LOWER KNIFE INSTALLATION & ADJUSTMENT:

THE UPPER KNIFE MUST BE REMOVED (per steps 1-13 of Upper Knife Removal pages 16-17) BEFORE THE LOWER KNIFE IS INSTALLED.

1. Once the upper knife is removed, cycle the knife bar back up to the top of it's stroke by manually releasing the trim clutch and turning the large pulley on the clutch clockwise (fig 28) until the knife bar is all the way up.

WARNING
TURNING THE CLUTCH PULLEY COUNTER CLOCKWISE AND/OR THE KNIFE PULL DOWN DRIVE SHAFT IN REVERSE WILL DAMAGE THE CLUTCH.

2. If installing a new or different lower knife, the set screws which push the lower knife forward against the upper knife, must be turned out so that the lower knife will not be in the way of the upper knife cycling down.
3. Install the five lower knife flat washers and screws, but do not fully tighten because the lower knife must be free to move during the next steps of installation/adjustments.
4. Manually cycle the knife bar (similar to step one) to the bottom of it's stroke. Install and secure the upper knife per upper knife removal & installation procedure page 16 & 17
5. Push lower knife firmly against the upper knife. Turn the lower knife adjustment set screws gently against the lower knife and secure with the nuts. Manually release the trim clutch and turn pulley until knife bar is at top of stroke.
6. Tighten the lower knife securing screws. **DO NOT PLACE FINGERS OR HAND BELOW UPPER KNIFE.**

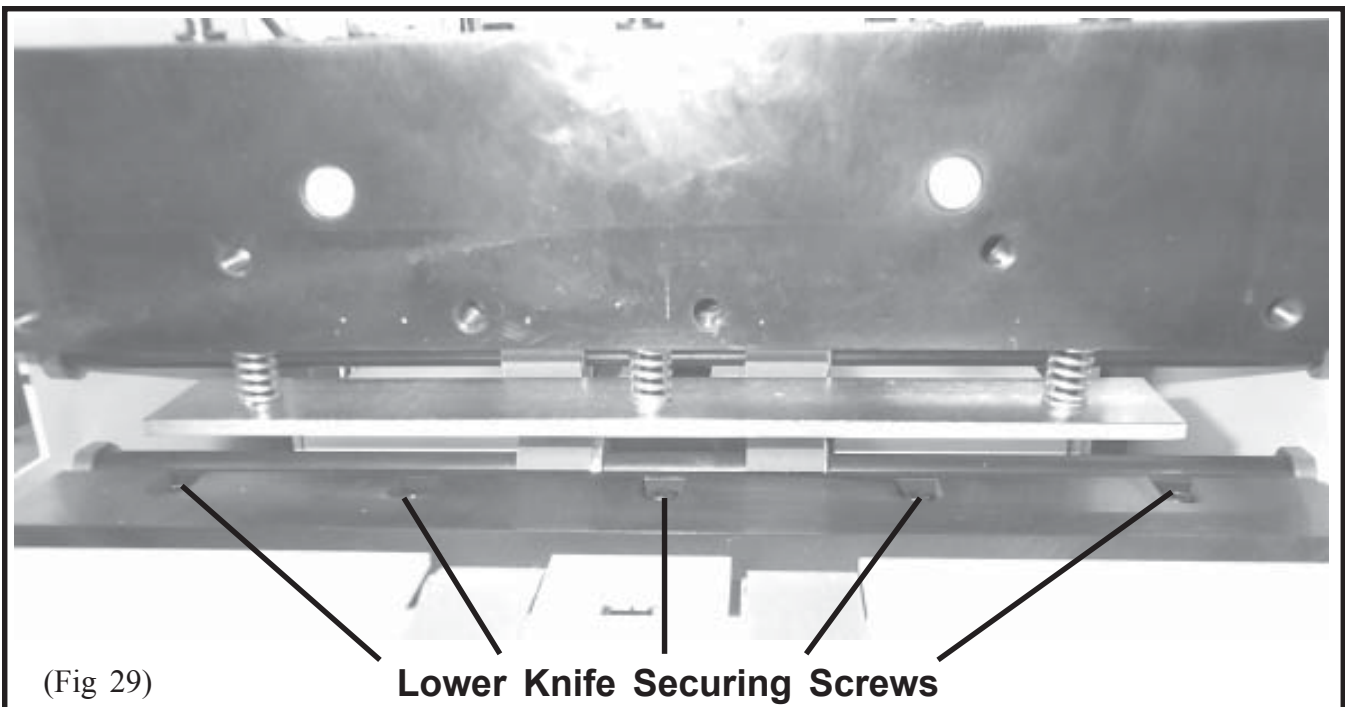

(Fig 29)

Lower Knife Securing Screws

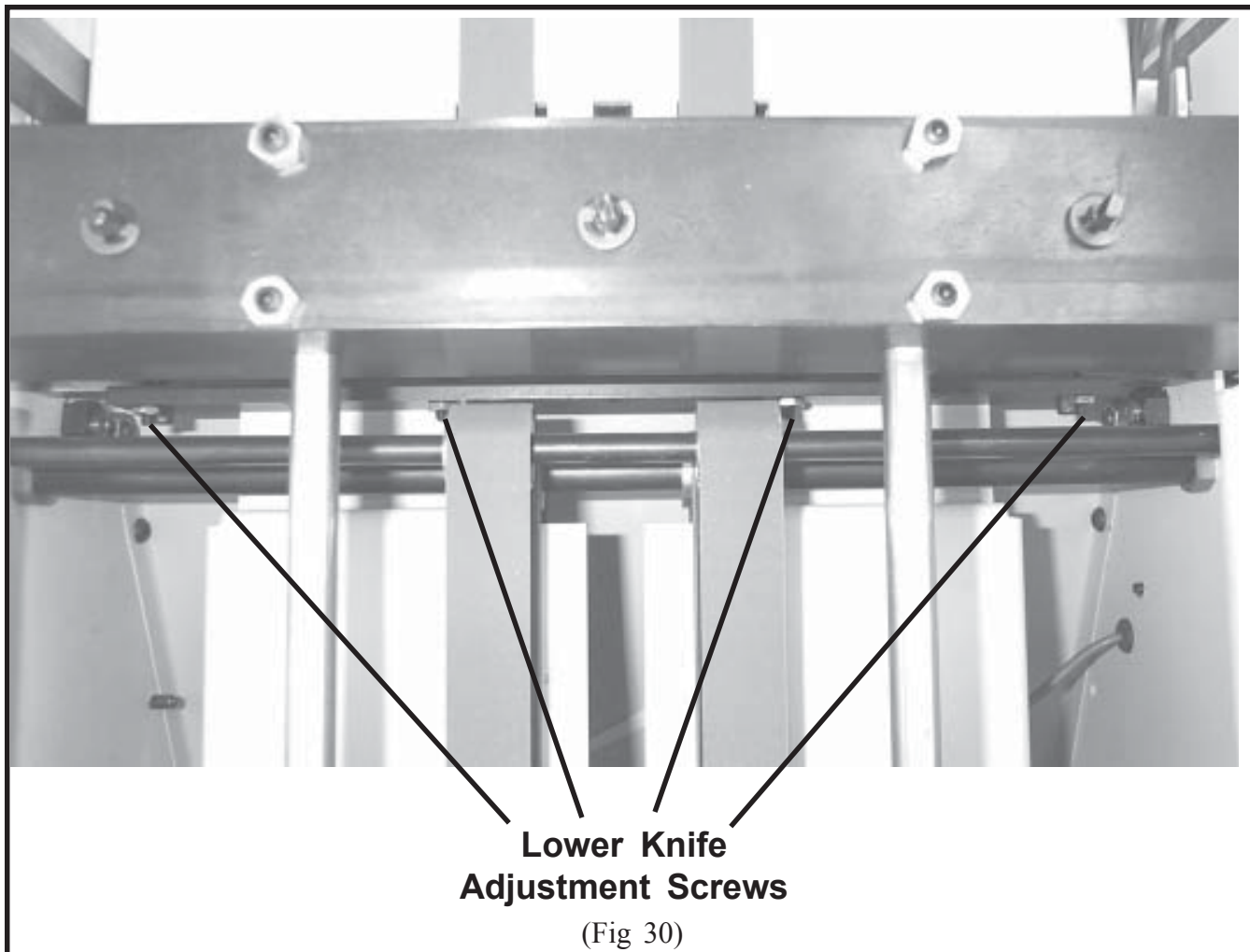

7. Manually release the trim clutch and cycle the knife bar through one cycle to check that the upper knife blade passes the lower knife smoothly without obstruction.
8. Place a single sheet of paper (large size) between the upper and lower knives, manually release the trim clutch and cycle the knife bar through one cycle. **KEEP HANDS CLEAR!**
9. Check that a clean cut is obtained across the full width of the knife blades.
10. If necessary loosen the lower knife securing screws at the point where adjustment is needed. Loosen the lower knife bar adjustment screws/nuts, move the lower knife closer to the upper knife by turning the appropriate adjustment screw (fig 30) (1/6 turn at a time), retighten lower knife securing screws and nuts of adjustment screws.
11. Perform another test cut and make further adjustments if necessary.

CLEARING A TRIMMING JAM:

If the maximum capacity of the trimmer is exceeded (50 sheets of 20# stock or 0.20" work thickness) the trimming knife will stall near the bottom of the trim cycle and not finish cutting the work. If this happens the jam should be cleared by removing the upper knife (follow steps 2 through 15 of UPPER KNIFE REMOVAL & INSTALLATION procedure page 16) and finishing the trim cycle by hand (follow step 1 of LOWER KNIFE INSTALLATION & ADJUSTMENT procedure page 18).

WARNING

DO NOT TRY TO CLEAR THE TRIMMING JAM BY TURNING THE CLUTCH PULLEY COUNTER CLOCKWISE AND/OR BY TURNING THE KNIFE PULL DOWN DRIVE SHAFT IN REVERSE OR THE CLUTCH WILL BE DAMAGED.

Trimmer

KNIFE CARE TIPS

CAUTION: KNIFE SAFETY! Knives are **DANGEROUS!!!** They are heavy and very sharp, even after use. Keep the edge away from your body and keep the area clear of other people when handling knives. Never touch the cutting edge! To prevent personal injury and damage to the knife, always keep knives in their holders with screws tightened. Others entering the area may not be aware of the dangers. Never attempt to hone, polish, or service the knife in any way. Failure to follow safety procedures may result in severe lacerations or dismemberment.

Nicks are visible on the cutting edge of upper or lower knife.

Store knives in a dry environment to prevent corrosion.

Never attempt to service a knife in any way without proper training. It is recommended to maintain a spare set of knives as a back up.

Knife blade life, or the time between sharpenings, can be affected by many factors. One important factor is the type of paper being cut. Abrasive paper, such as recycled paper, soft paper such as newsprint paper, and bound books can all significantly shorten knife blade life. Cutting pure paper, such as bond paper with no recycled content will cause less wear on the cutting blade. In all cases the operator should continually check the quality of the cut to determine when the knife needs to be sharpened. Some characteristics that indicate a blade needs sharpening are:

The knife hesitates or stalls while making a cut.

The top sheets are not all cut to the same length (usually the top few sheets are longer than the rest of the sheets - this is sometimes called "draw")

Cut marks appear on the cut face of the paper.

The knife and/or drive makes a "rough" sound as the knife passes through the paper.

NOTES:

Trimmer

TROUBLE SHOOTING

PROBLEM:

SOLUTION:

1. The trimmer will not turn on.	<ol style="list-style-type: none">1. Plug unit into appropriate power supply.2. Depress the "Power On/Off" switch.3. If there is no green light:<ol style="list-style-type: none">a. Check for proper line voltage. (115V or 220V)b. Make sure the top guard is closed.c. Check the 1 amp control circuit fuse.4. The green light is on, but the motor does not run.<ol style="list-style-type: none">a. Depress the "Start/Reset" toggle switch.b. Check the 6A (115V) or 3A (220V) motor fuse.
2. Work is conveyed through trimmer without being trimmed.	<ol style="list-style-type: none">1. Depress the "Trimming On/Off" switch to the "On" position.
3. Trim is not square to book.	<ol style="list-style-type: none">1. The work does not stop flat against the back stop gate.<ol style="list-style-type: none">a. Check that knife bar begins cycle at top of stroke.b. Make sure all lower and upper conveyor belts on the infeed table and middle conveyor area are clean and operating properly.c. Switch the "Belt Drive" rotary switch to the next higher number position.2. Backstop gate is not square to lower knife.
4. Work is not trimmed clean.	<ol style="list-style-type: none">1. Dull and/or damaged upper and/or lower knife.
5. The upper knife does not go up far enough to allow the work to pass below.	<ol style="list-style-type: none">1. The proximity switch that senses the knife bar needs to be adjusted upward.

6. Knife stalls near bottom of trim cycle and does not cut through work.

1. Maximum work thickness has been exceeded. Call MBM dealer for service.

Trimmer

Circuit Board: Light Layout

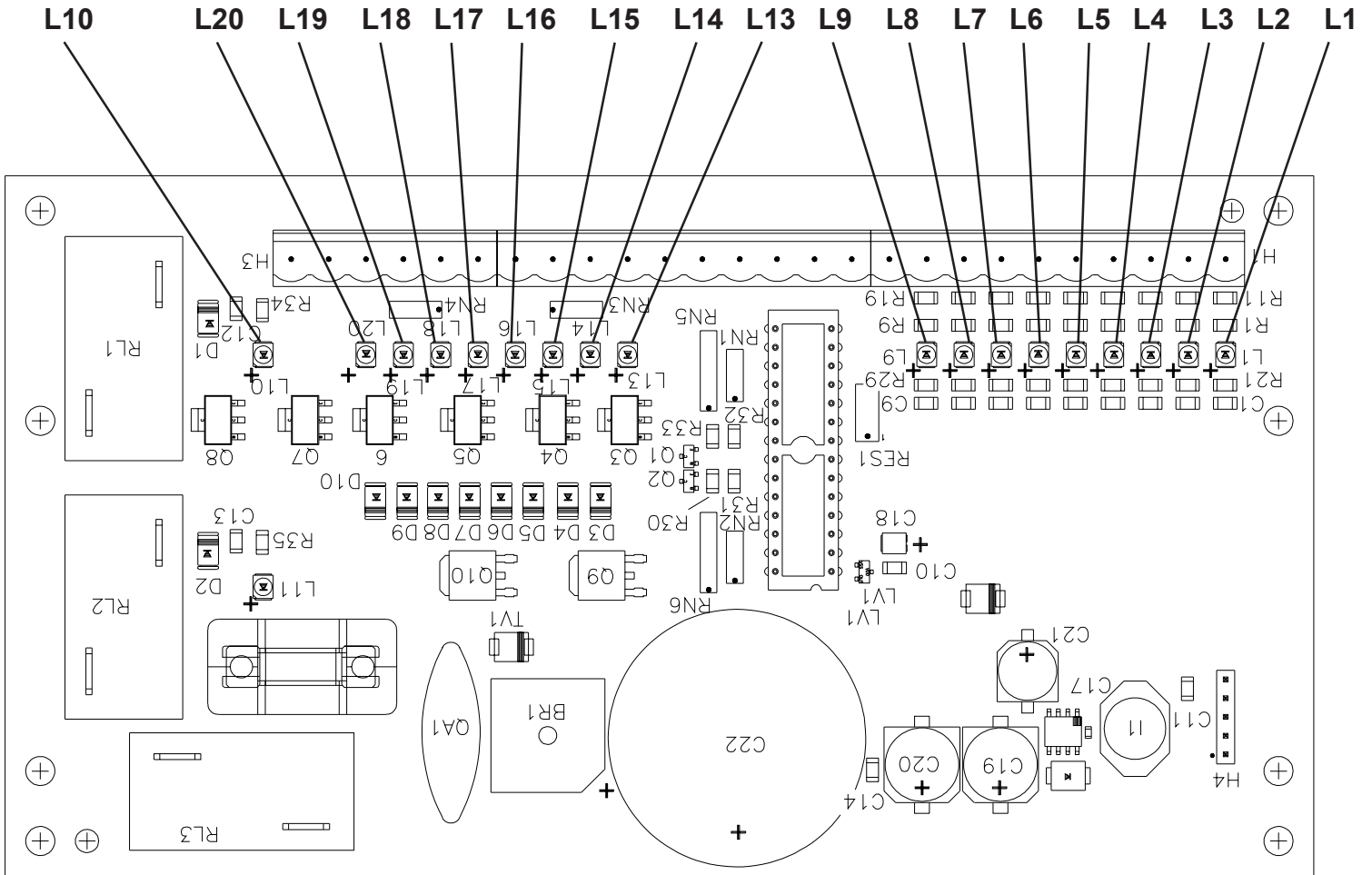

(RTM1172A-Layout1)

INPUTS L1-L9 (Yellow)

LIGHT	APPLICATION
L1	Trim/No Trim Switch
L2	Knife Change Switch
L3	Knife Proximity Sensor
L4	Belt Drive Selector Switch
L5	Belt Drive Selector Switch
L6	Infeed Photosensor
L7	Gate Photosensor
L8	Start/Reset Switch
L9	Belt Drive Selector Switch

OUTPUTS L10-L20 (Red)

LIGHT	APPLICATION
L10	Motor Power Relay
L13	Jam Light
L14	N/A
L15	N/A
L16	Discharge Clutch
L17	Conveyor Clutch
L18	Jam Detector Relay
L19	Gate Solenoid
L20	Cut Clutch

Circuit Board: Normal Operation Light Sequences

PROCESS PERFORMED	ILLUMINATED LIGHTS	SIDE NOTE
1) Power Switch (on)	L3, L6, L7, L13, L18	Have the belt drive position switch (fig. 19) in the zero position, and also have the trimming switch on, this will produce the desired light configuration. When the switch is turned off there are no lights lit.
2) Start/Reset Button	L3, L6, L7, L10, L17	If holding the reset button down, L8, L16, and L19 will also be lit. If only pushed and released, the previously mentioned lights will only momentarily light. Both of these previously mentioned conditions remain true for any subsequent start/reset thereafter.
3) Emergency Stop	NONE	If the emergency stop button is twisted back into the nominal position, the lights will display as in process number 1.
4) Trimming Switch	See Side Note	If the trimming switch is on, the lights will look the same as in process 2. If the switch is off, the same is true but L1 is also lit.
5) Knife Change Switch	*L3, L6, *L7, L13, L18	If holding the button down, the knife will cycle up and down and the following lights will light. L2, L3, L6, L7, L10, L13, L16, L17, L18, and L20 (L3 and L7 will flash on and off simultaneously).
6) Belt Drive Knob	See Side Note	Starting at position 1: L4, L5, and L9 will be off. At position 2 L4 will turn on. At position 3 L4 will turn off and L5 will turn on. At position 4 both L4 and L5 will be on. At position 5 L4 and L5 will be off and L9 will turn on. At position 6 L4 and L9 will be on.
7) Open Lid	NONE	If the lid is returned to the closed position, the lights will display as in process 1.
8) Passing Work Through Trimmer	L10, See Side Note	Inputs: L6 first turns off and then relights. This is closely followed by L7 turning off, and then L3 turning off. Outputs: L17 turns off immediately followed by L20 turning on then off. This is followed by L16, L17, and L19 turning on and then L16 and L19 quickly turn off together. When done the light pattern should be that of process 2.
9) Infeed Photosensor	See Side Note	Covering the front infeed photosensor will turn off L6. If L6 is covered for approximately 5 seconds, the machine perceives a jam and L3, L7, L13, and L18 turn on.
10) Gate Photosensor	See Side Note	Covering the gate photosensor will turn off L7. The operational light sequence will follow that of process 8, but L6 will not relight before L7 turns off. Therefore if L6 and L7 are out together, all lights turn off except L3, L13, and L18. A jam occurs when both the gate and infeed photosensors are covered at the same time.
11) Auto Shut-Down	L3, L6, L7, See Side Note	If the machine is on and running but not being used for about 2 minutes, it will auto shutdown. L10 and L17 will turn off, and L13 and L18 go on.

* Denotes that the light may or may not be lit.



3134 Industry Dr. N. Charleston, SC 29418
1-800-223-2508 1-843-552-2700
Fax: 1-843-552-2974
www.mbmcorp.com

FORM QF110 5-20-04