

Skyline

Book Binding Machines & Supplies

Sales • Service • Repair

Professional Service – Fast Nationwide Shipping

1-866-455-9900

www.OnlineSkyline.com CustomerService@onlineskyline.com

OPERATION MANUAL

**MBM TABLE TOP COLLATOR
FC-10**







Read this "Operation Manual" carefully before use.
Keep it at specific place for handy reference.

Safety Instructions

Definition of Symbols and Notes

In this manual following names and signs stand for possible dangers.

	<p>Danger This Symbol stands for immediate danger threatening the life and health of persons. Disregarding these instructions may cause severe damage to health and even serious injuries.</p>
	<p>Caution This symbol stands for an endangering situation that may occur. Disregarding these instructions may lead to slight injuries or damage to property.</p>
	<p>Note This symbol stands for notes, operational hints and other useful information. They are convenient for exploiting the machine's functional abilities.</p>

Danger	
	<p>Operate the collator with designated AC current only. Use an exclusive outlet, as overloading may cause fire or an electrical shock.</p>
	<p>Do not plug or unplug the power cord from an outlet with a wet hand; it can result in an electrical shock.</p>

Caution	
	<p>Do not touch any part of the drive, including the roller, with a hand. It may cause an injury.</p>
	<p>Do not allow hair, a necktie, a necklace or other things to get too close to the drive, including the roller, as bodily injury can result.</p>
	<p>Do not install the machine in an unstable place, such as one that shakes or tilts. The machine may fall, causing breakage or physical injury.</p>
	<p>Do not install the machine in a humid or dusty place; excessive humidity and dust can cause fire or physical injury.</p>
	<p>Never unplug the power cord from the outlet by gripping the cord itself. Doing so may damage the cord, causing fire or injury. Always disconnect the machine by gripping the plug.</p>
	<p>Make sure that the paper feed table, auxiliary table, stacking table and the plate to prevent the machine from falling are properly set. They may cause an injury if they come off. Also, take care not to cause the machine to fall when attaching or removing the stacking table and auxiliary table.</p>
	<p>Be sure to remove the power plug from the outlet when moving the machine, otherwise it may damage the cord, causing fire or an injury.</p>
	<p>When the collator will not be used for several days, such during consecutive holidays, etc., be sure to unplug the power cord from the outlet for safety's sake.</p>
	<p>Do not place receptacles containing water, such as vases, flowerpots and cups, on the machine. Spilled water can cause fire or an electrical shock.</p>
	<p>Do not damage, destroy or process the power plug and cord. Placing heavy things on the cord, pulling it, or bending it forcibly may damage the plug and cord and cause fire or an electrical shock.</p>
	<p>Do not remove the cover of the machine, as it can cause an electrical shock or injury.</p>
	<p>Do not dismantle the machine, it may cause fire or an electrical shock.</p>
	<p>Continuing operation in spite of irregularities, such as overheating, smoking and unusual odor, may cause fire or an electrical shock. In such cases, turn off the power switch, remove the plug from the outlet and contact your dealer.</p>
	<p>When foreign substances, such as metal fragments, water or other liquids, fall into the machine, turn off the power switch immediately, remove the plug from the outlet and contact your dealer. Continued operation with such substances in the machine may cause fire or an electrical shock.</p>

INTRODUCTION

Read this “Operation Manual” carefully before use.

Keep it at a specific place for handy reference.

Since the specifications of this machine are subject to change, be sure not to mistake this manual for one of a different mode, descriptions of may differ.

CONTENTS

1. PRECAUTIONS FOR INSTALLATION AND USE.....	4
1.1 Installation	4
1.2 Place for installation	5
1.3 Confirmation of contents and quantity of attachments.....	7
2. COMPONENTS	8
2.1 Overview.....	8
2.2 Operation Panel	9
3. PREPARATIONS FOR USE	11
3.1 Installing attachments	11
3.2 Setting paper feed pressure.....	14
3.3 Setting separator pressure	14
4. MATTERS TO NOTE	15
4.1 Definitions	15
4.2 Characteristics and purpose of use	15
4.3 When not in use	15
5. OPERATIONS.....	16
5.1 Procedure and method	16
5.1.1 Activating power	16
5.1.2 Setting of paper on feed tables	16
5.1.3 Setting of stacking guides, poles, etc.....	18
5.1.4 Collation	18
5.2 Counter	19
5.2.1 Using adding mode.....	19
5.2.2 Using subtracting mode.....	19
5.3 Setting collation speed.....	19
5.4 Setting normal or alternate collation mode.....	20
5.5 Crisscross stacking (or straight stacking)	21
5.6 Insert mode	21
5.7 Programmed insert mode.....	22
5.8 Storing Insert/Programmed Insert mode data.....	23
5.9 Calling up the Insert/Programmed Insert mode data	24
5.10 Repeat mode	25
5.11 Changing light intensity.....	26
5.11.1 Changing system constant “P”	26

6.	MAINTENANCE, INSPECTION, CONSUMABLES	27
6.1	Important for maintenance and inspection	27
6.2	Usual maintenance.....	27
6.3	Consumables.....	28
7.	TROUBLE SHOOTING	29
7.1	Corrective actions to be taken when LED lamps are lit or flashing	29
7.2	Troubleshooting.....	31
7.3.	In case of breakdown.....	32
8.	RELOCATION OR DISPOSAL.....	33
8.1	Relocation.....	33
8.1.1	Removal of the machine from its present location	33
8.1.2	Transport.....	33
8.1.3	Installation	33
8.2	Disposal	33
9.	PRODUCT SPECIFICATIONS	34
9.1	Specifications.....	34
9.2	Optional parts.....	34

1. PRECAUTIONS FOR INSTALLATION AND USE

1.1 Installation



Caution

Use the optional collator table exclusively designed for this machine and do not install the machine in an unstable place, such as one that shakes or tilts. The machine may fall, causing a damage or bodily injury.

Do not install the machine in a humid or dusty place, as excessive humidity and dust may cause fire and physical injury.

Install this machine only by the dealer serviceman or equivalently qualified person who is specialized in this machine in according with the procedures and method mentioned in this manual.

When installing this machine, use the optional collator table exclusively designed for this machine.

The table is equipped with safety devices, such as metal fittings **B** to prevent the machine from falling, and it has been engineered so that, whether the machine operate alone or in combination with a post-processor (stapler-puncher) or other options, the machine(s) will be balanced as a whole.

NOTES:

In case the collator is placed on the table or the like other than the dedicated table for the collator, be sure to install the metal fitting **A to prevent the machine from falling.**

How to install metal fitting **A** to prevent the machine from falling

For fixing metal fitting **A** to the wall, select the sturdy and permanently stabilized place where the metal fitting **A** will not come off even in case 36 lbs. power is continuously applied at upper part of the collator.

1. The collator should be placed on the steady and stable table or the like.
2. Fix the metal fitting **A** on the cover panel of the collator using four SKSW4x8 screw + washers set (supplied with the machine).
3. Find suitable holes in the metal fitting **A** so that edge of metal fitting **A** fits right distance to the wall.
4. Fix the metal fitting **A** on the wall of the room. Two holes of 8 mm dia. for screw are provided on the metal fitting **A**. Use two screws (1/4" dia. x 2" long), two washers (1/4"+ dia.) and type S8 (or equivalent) screw anchors (5/16" dia. x 1-9/16" long) or larger ones depending on the material of the wall. (These wall screws, washers and screw anchors are not supplied with the machine)

A.

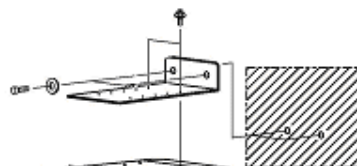

B.

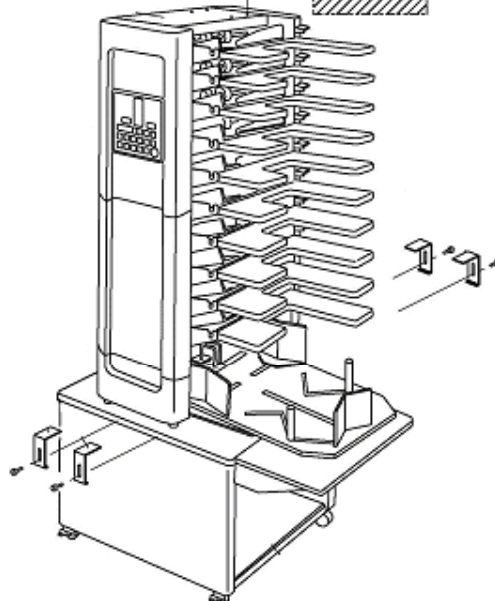

1.2 Place for installation

Avoid installing the machine in the following places for the sake of safety and to prevent mechanical problems.

[Precautions for installation]

- Locations with extremely high or low temperatures. Room temperature should be between 40 and 95 degrees.
- Locations with the potential for producing electrical leaks, for example, owing to splashing water.
- Near heat sources
- Places exposed to wind
- Narrow spots with poor ventilation, or dark places
- Locations exposed to direct sunlight or other powerful light sources. Direct sunlight or other strong light sources may cause the optical sensor to malfunction. Install the machine in an appropriate place or shield the light with a heavy curtain or other material.

BE SURE TO FOLLOW THESE INSTRUCTIONS TO AVOID MALFUNCTION.

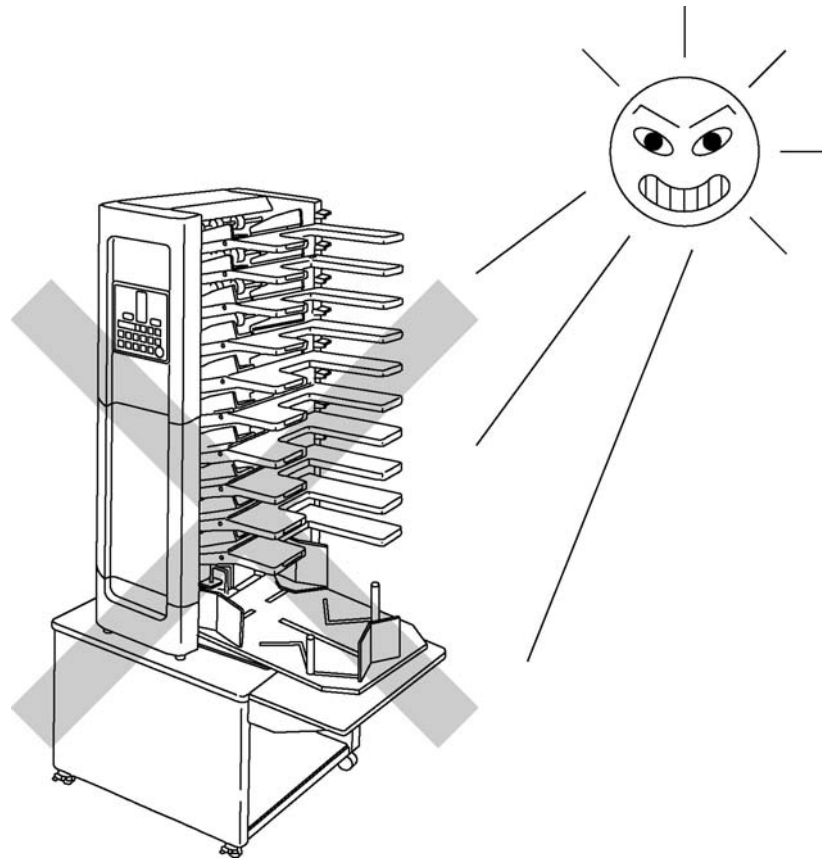

1.3 Confirmation of contents and quantity of attachments

After unpacking the collator, check the attachments.
Should any part be missing, contact your dealer immediately.

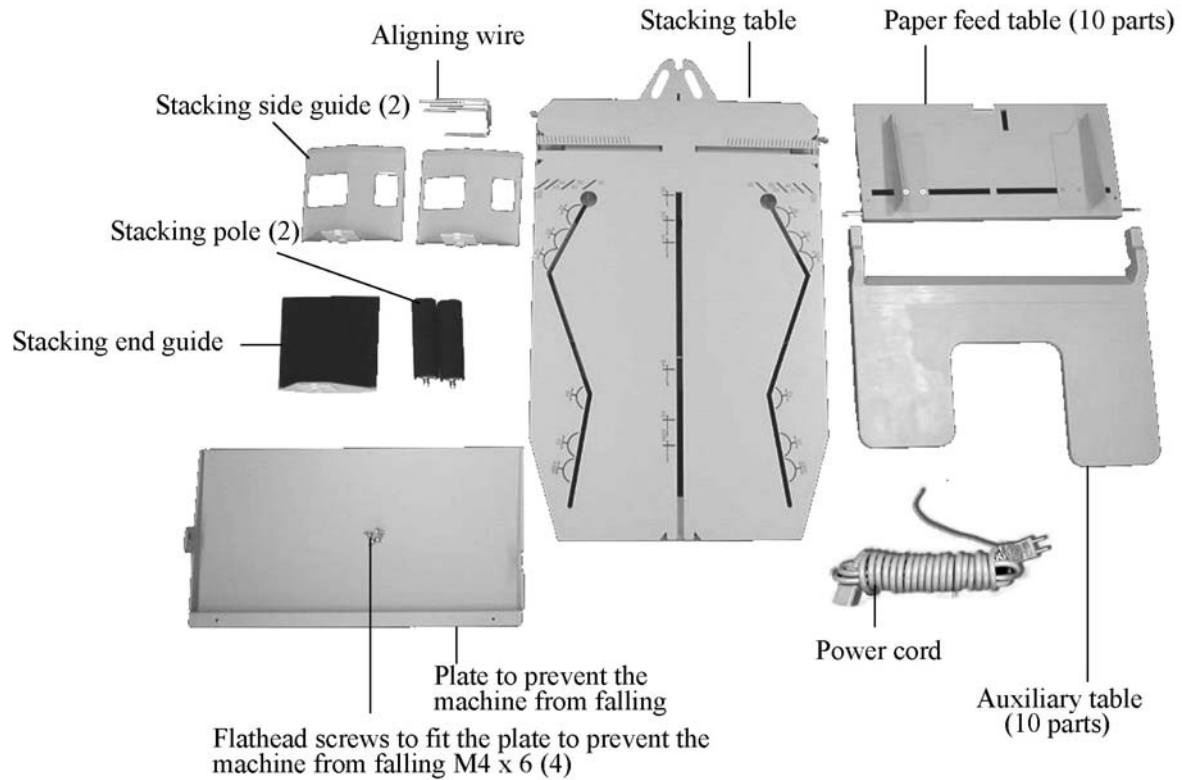

IMPORTANT NOTES:

**FOR ASSMBLYING MACHINE REFER PAGE 11,
3. PREPARATION FOR USE.**

2. COMPONENTS

2.1 Overview

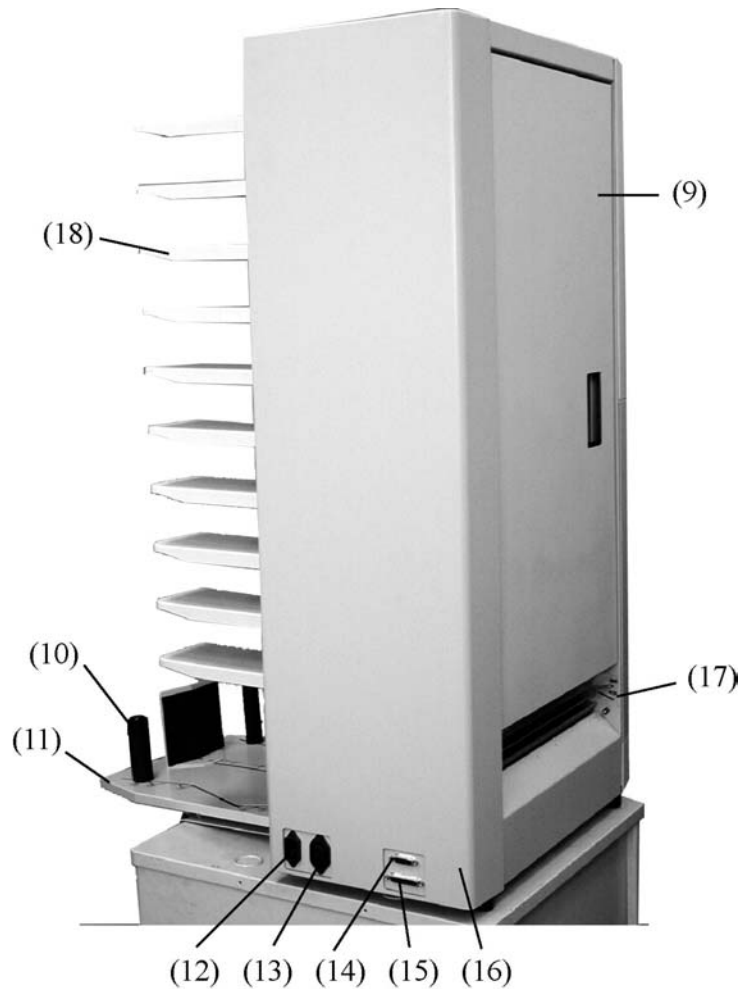

Right Connector (14) and left Connector (15) are non-limited power circuit.

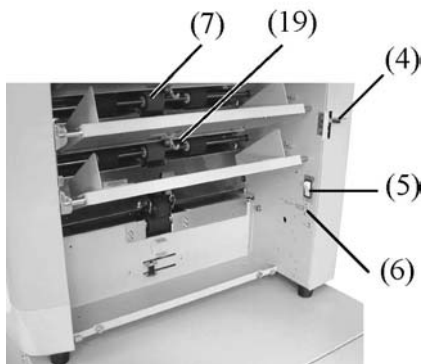

No.	Name
(1)	Operation Panel
(2)	Paper guide
(3)	Paper feed table
(4)	Paper feed pressure shifting lever
(5)	Power switch
(6)	Circuit breaker
(7)	Paper feed roller
(8)	Left cover
(9)	Back door
(10)	Stacking pole
(11)	Stacking table
(12)	Inlet
(13)	Outlet (to connect optional stapler puncher and stacker)
(14)	Right connector
(15)	Light connector (Connect to left tower / option)
(16)	Right cover
(17)	Shift lever for paper direction
(18)	Auxiliary table
(19)	Paper detection wire

2.2 Operation Panel

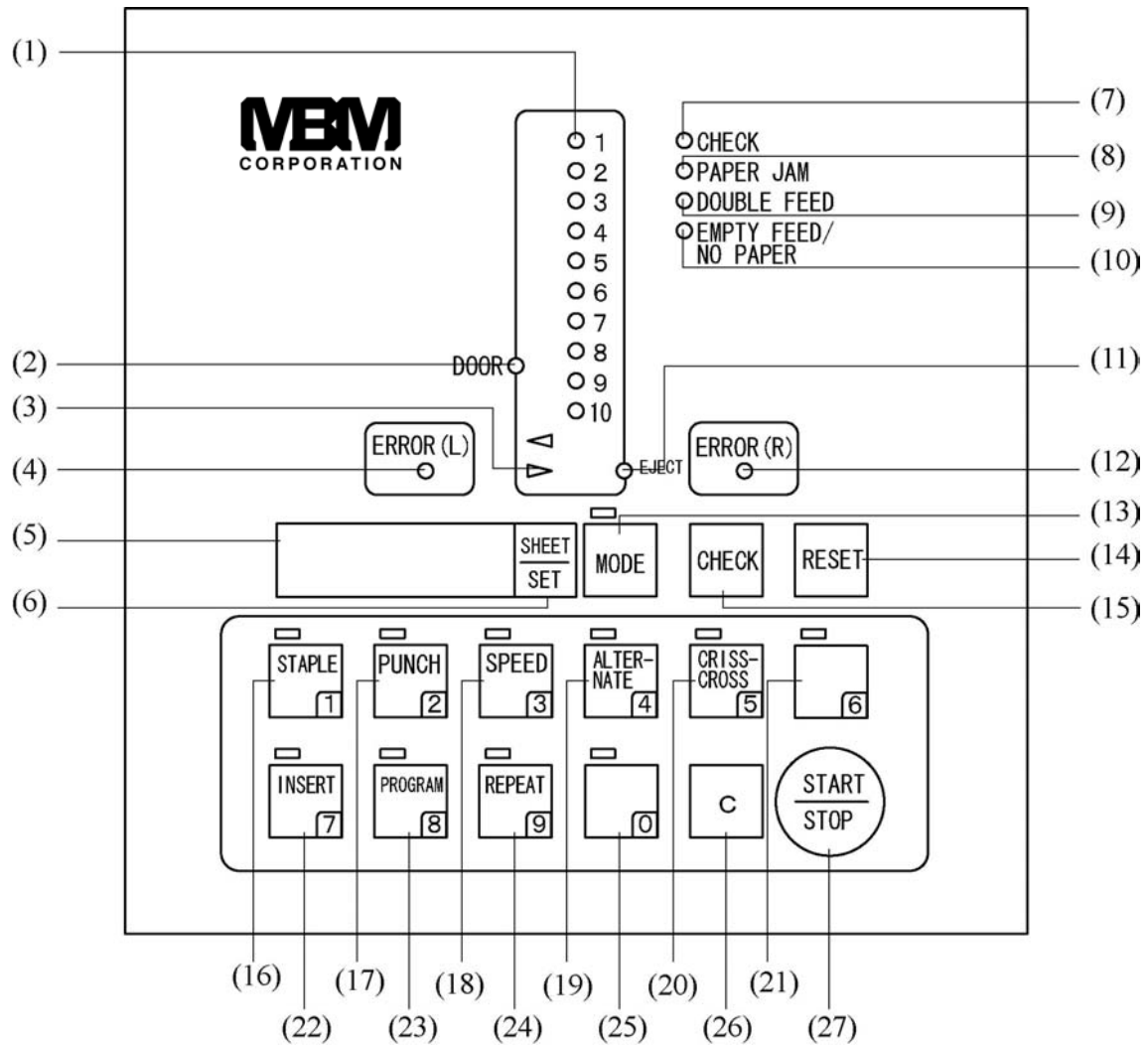

No	Name	Function
(1)	[Station] LED lamp	Shows the collating status of each station 1 through 10.
(2)	[DOOR] lamp	Lights up when the back door is open.
(3)		Shows direction of paper ejection when lighted green.
(4)	[ERROR (L)] lamp	Indicates an error in the left side collator when lighted red.
(5)	COUNTER	Displays the number of collated sheets. “Err” is displayed in the event of an error.
(6)	[SHEET/SET]	Press the key to change the number of collated sets and the number of batches in Insert and Programmed Insert modes.
(7)	[CHECK] lamp	Lights green to when trial feed is complete.
(8)	[PAPER JAM] lamp	Lights red should a paper jam occur.
(9)	[DOUBLE FEED] lamp	Flashes red should double feed occur.

No.	Name	Function
(10)	EMPTY FEE/NO PAPER lamp	Flashes green in the event of no paper or no feed. In case of no paper, the lamp for the relevant station blinks slowly. If empty feed, the lamp for the relevant station blinks quickly.
(11)	EJECT lamp	Lights should a paper ejection jam occur or when the stacking table is full.
(12)	ERROR(R) lamp	Lighted red, this key warns of an error in the right side collator.
(13)	Mode key	When lighted green, various functions can be programmed. When using function keys, press this key first to light it green (goes out after five seconds).
(14)	RESET key	Press to reset error. When pressed for three seconds, the paper feed table lowers. Pressed for three seconds while the machine is in stand-by mode, the main motor will idle.
(15)	CHECK key	Press for trial paper feed so the machine will memorize stations to be used and the thickness of paper.
(16)	STAPLE/1 key	When lighted green, staple processing will occur; when not lit, stapling will not occur. Also used to display 1 on the counter.
(17)	PUNCH/2 key	This function does not apply for units in North America.
(18)	SPEED/3 key	When lighted green, high-speed collation occurs; when not lit, collation will be slow. Also used to display 3 on the counter.
(19)	ALTERNATE/4 key	When lighted green, Alternate mode is selected; when not lit, Normal mode is selected. Also used to display 4 on the counter.
(20)	CRISSCROSS/5 key	When lighted green, Crisscross mode is selected; when not lit, straight mode is selected. Also used to display 5 on the counter.
(21)	6 key	Used to display 6 on the counter.
(22)	INSERT/7 key	When lighted green, Insert mode is selected. Also used to display 7 on the counter.
(23)	PROGRAM/8 key	When lighted green, Programmed insert mode is selected. Also used to display 8 on the counter.
(24)	REPEAT/9 key	When lighted green, Crisscross stacker continuously moves each time pre-programmed number of collated sets are ejected. Also used to display 9 on the counter.
(25)	O key	Used to set the counter to O.
(26)	C key	Press to return the counter to zero. It also turns off the lamp. ¹⁰
(27)	START/STOP key	Press to start or stop collator operation.

3. PREPARATIONS FOR USE

3.1 Installing attachments

1. Mount the plate to prevent the machine from falling

- (1) Insert under the collator the plate to prevent the machine from falling.
- (2) Attach the plate by aligning the four holes of the machine body with those of the plate and securing it with the 4 flathead screws RK4x8.

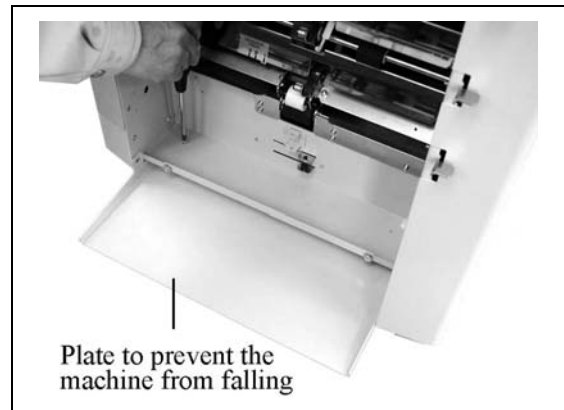

2. Power connection

- (1) Insert the power plug in its receptacle on the back of the collator.
- (2) Insert the plug into the wall outlet.



⚠ Caution!

It is strongly advised not to use an extension cord or overloaded one electrical outlet, as it can cause erroneous operation.

3. Stacking table assembly

- (1) Insert the 2 stacking side guides and the stacking end guide in the stacking table, making sure not to set them in the wrong direction.
- (2) Insert the 2 stacking poles in the holes and fix them while sliding them along the slot.

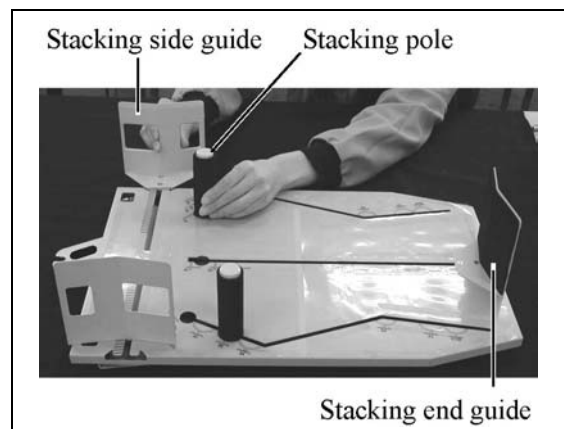

4. Stacking table

- (1) Fit the tumbler-shaped hooks on the stacking table into the hooks of the front foot rubber base (two places) while fitting the tip notch of the stacking table to the collator's crisscross roller, then tilt the stacker table on either right or left side (right with the roller on the right, left when on the left), and insert the stacking table hooks in the opening on the front foot rubber base. Make sure the hooks are firmly fitted on both right and left sides.

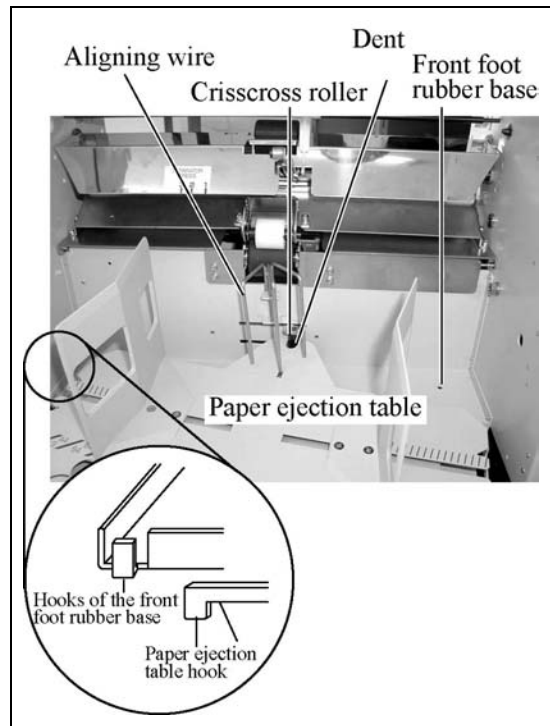

- (2) Install the aligning wire.

- [1] After installing the stacking table in the collator, insert the rear part of the aligning wire into the wire insertion hole in the collator.
- [2] Pinch the bent part at the aligning wire tip with your fingers and draw it to the front. Then, fit it on the wire insertion hole in the stacking table.
- [3] While pinching the wire as it is, insert the bent part at the wire tip into the wire insertion hole in the stacking table.

Remarks

- a) Make sure the stacking table and aligning wire are properly attached to the machine; wrong attachment may cause the machine to rock or paper to jam when ejected.
- b) Take care so that fingers or hands are not caught in collator operating parts.

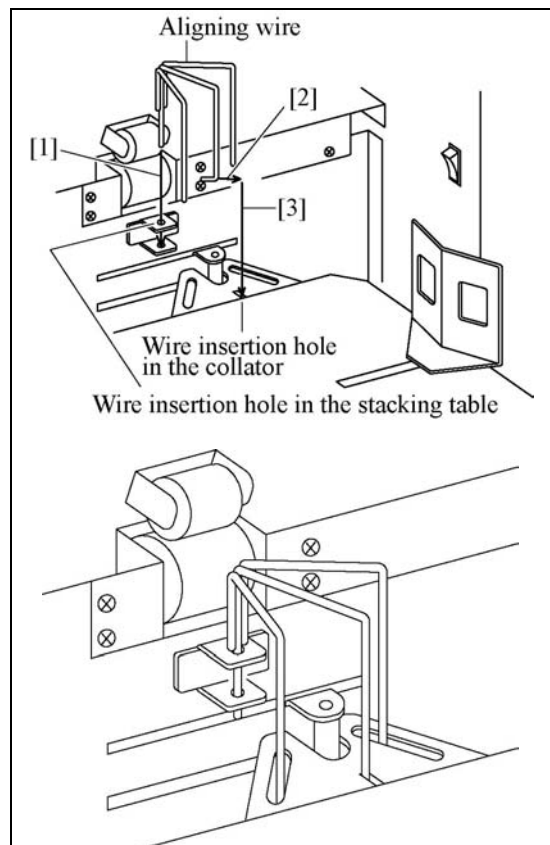

Caution!

Make sure that the paper feed table, the auxiliary table and the stacking table are properly set. They may cause an injury if they come off. Also, take care not to cause the machine to fall when attaching or removing the stacking table and auxiliary table.

5. Paper feed table

- (1) First, make sure the table lift lever is in its low position. If it is not, turn the power switch on and press the Reset key for three seconds or more to lower the lever. Normally, the lever is below the paper feed table; by lifting the lever, the feed table will rise. If the lever is higher than the table, paper cannot be fed as the table cannot be raised.

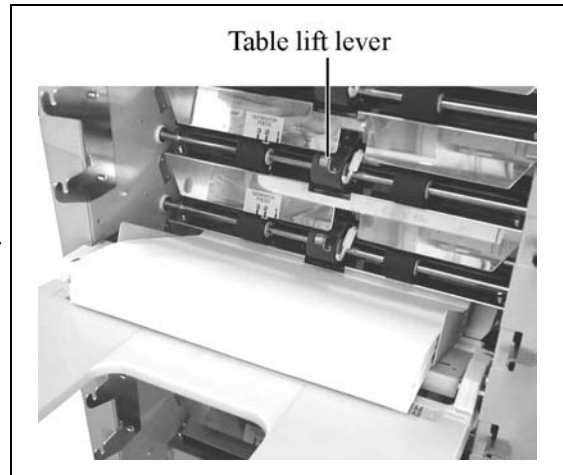

- (2) Insert the right side shaft of the paper feed table in the hole on the side opposite the collator operation side, and mount the left shaft on the plate with the U-shape slot.

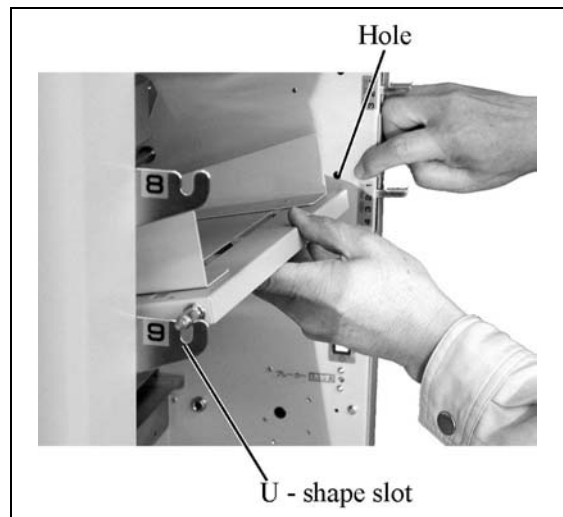

- (3) Fit the auxiliary table slots (two places) on both side shafts of the paper feed table.

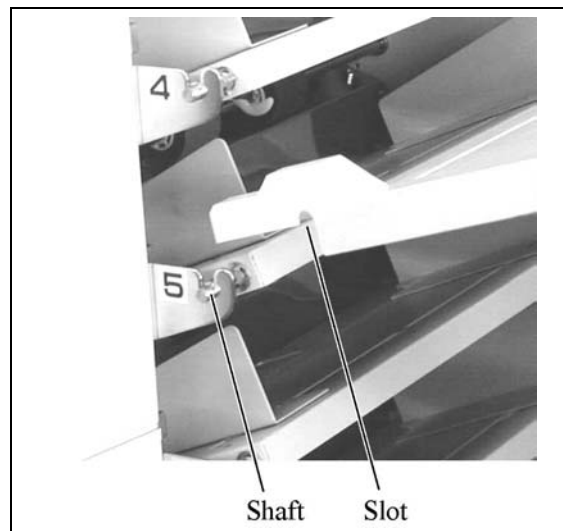

3.2 Setting paper feed pressure

- Position the paper feed pressure shift lever at [2] for normal jobs (ordinary paper).
- Four different degrees of pressure can be selected for Stations 1 and 10.
- Three different degrees of pressure can be selected for Stations 2 to 9.
- Select [1] (weak) when double feed occurs.
- Select [3] (strong) when paper feed slip occurs.



3.3 Setting separator pressure

- For regular jobs processing ordinary paper, set the separator pressure shift lever at [2]. Remove the paper feed table when changing separator pressure.
- Three different degrees of pressure can be selected for all stations.
- Select [1] (weak) when paper feed slip occurs.
- Select [3] (strong) when double feed occurs.
- * While separator pressure is classified as [1], [2] and [3] on the collator display, for special cases, [4] is built in next to [3]. Use this when double feed is so frequent that [3] cannot prevent it.

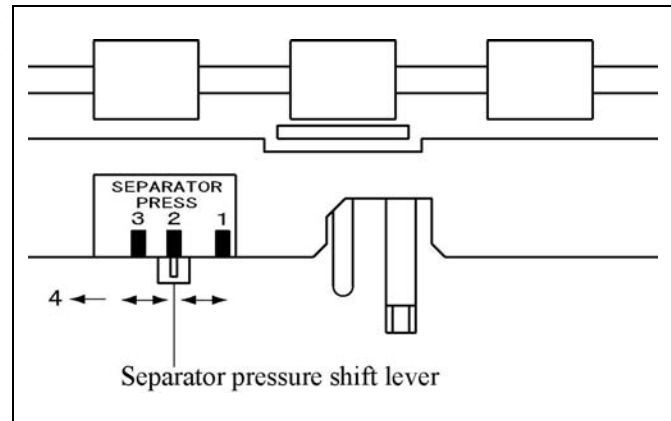

4. MATTERS TO NOTE

4.1 Definitions

Name	Explanation
Paper jam	Paper stuck in the machine
Double feed	Feeding two or more sheets together
Paper feed slip	Paper not being fed
Fan out	Pulling out stuck sheets by blowing air

4.2 Characteristics and purpose of use

- Automatic collation of printed or copied documents in page sequence.
- Enables alternate collation. Alternate collation allows using two stations as one, making for easy collation of massive stacks of paper.
- Electric paper feed table, which raises and lowers automatically, provides for fast setting.

4.3 When not in use

- Remove the power plug from the outlet.
- Cover the machine.

5. OPERATIONS

5.1. Procedure and method

5.1.1. Activating power

Turn the power switch on.

⚠ Caution!

Before turning the power switch to ON, make sure that the paper feed, auxiliary and stacking tables are fully inserted.

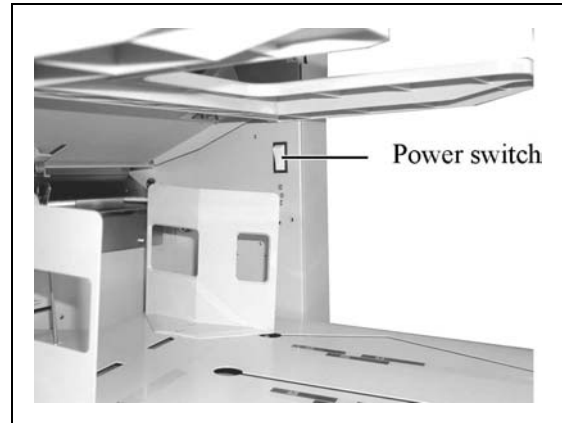

5.1.2 Setting of paper on feed tables

- (1) Load paper on the paper feed tables and hold it firmly using the lateral paper guides.

👉 Note

[How to fan out sheets]

- (1) Pinch the sheets of paper at both ends.
- (2) Bend them to admit air.
(Loosen the force lightly and pinch them again after bending)
- (3) Jog and align the sheets vertically.

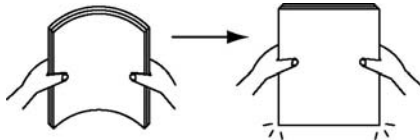

Remarks

- a) Use the fill line on the paper guide as the loading capacity. In case of printed paper, do not load too much as it tends to swell.
- b) Fan out sheets well and then load them on the feed table. Failure to properly fan sheets may lead to trouble.
- c) Align sheets at the edges and insert them until they lightly strike the forward guide. Failure to properly align sheets may lead to double feed or no feed.
- d) Make sure any ink on the paper is dry. Let ink dry before loading paper. Wet ink soils the feed rollers and can lead to malfunction, such as double feed or no feed.
- e) Copied sheets may cause wrong feed or stacking error owing to electrostatic charge. Static electricity can be controlled by spraying a retail static eliminator on the feed rollers and the front edge of the paper. Too, since copied sheets are apt to curl at the edges; straighten or invert them before feed table loading.
- f) Be sure to load no-carbon-required paper (general quality) with the color developing side (usually the print side) down, otherwise the side coated with color former will probably be marked with rubbed traces when contacting the feed roller.
- g) Front and back sides of ejected paper change according to ejected direction (with independent use or when connected). Be very careful when connecting with after processing equipment.

(2) Paper loading order

1) Paper with the printed side down

Load the paper on the feed tables from bottom to top in ascending order of pages.

In this case Page 1 appears at the top of collated sheets on the stacking table.

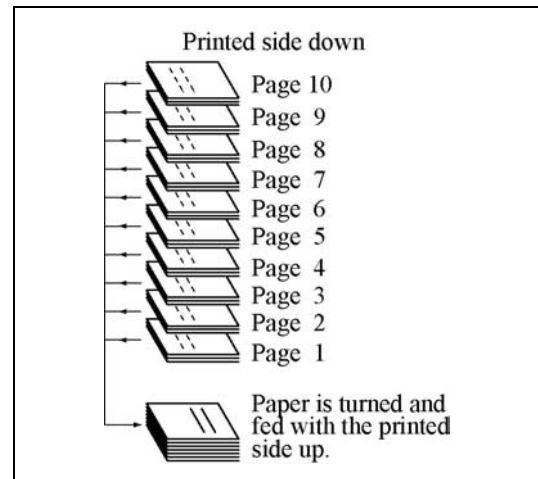

2) Paper with the printed side up

Load the paper on the feed tables from top to bottom in ascending order of pages. Paper is fed to the stacking table turned over.

In this case Page 1 is at the bottom of collated sheets on the stacking table.

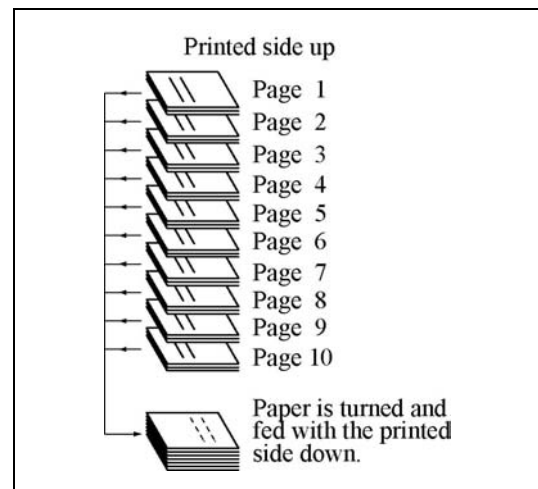

Note

How to load a paper with a small number of pages (using less than 10 stations)

- **In case the collator is used independently or a staple is connected with it, Load the paper in order from the bottom (10th station). This way prevents disorder in paper ejection and facilitates the processing speed.**
- **In case optional machines are connected with the collator (another collator, namely two collators connected to be used, and a large-capacity stacker), Load the paper in order from the top (1st station). This way prevents paper jam.**

5.1.3 Setting of stacking guides, poles, etc.

Set the right and left side guides, stacking poles (two) and stacking end guide, respectively according to paper size. If the paper is caught by the guides or not properly aligned, make fine adjustments by moving the guides forward or backward, right or left.

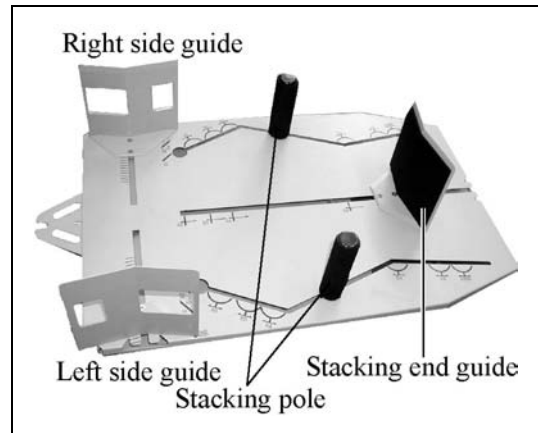

Remarks

- a) With postcards or organizer-notebook size paper, only straight stacking is recommended.
- b) Stacking arrangement changes according to the collating speed. With high-speed collation, ejected paper rebounds more strongly when striking the stacking end guide or pole, causing greater disorder. In case of warped paper, the faster collation becomes, the more it is apt to roll, worsening the arrangement.

However, since, owing to various factors, collation is not always better when stacked slowly, collation speed should be set case by case.

Paper type -- sturdy or easily torn -- also affects collation and stacking.

Note

- a) In case of improper stacking
Set the standard on the positioning gauge for the pole guide shown on the stacking table and move the pole guide to the left (to narrow the gap between pole guide and collated paper). Move the right and left side guides uniformly inward (to narrow the gap between pole and paper) based on the positioning gauge. Adjust the positioning guides gradually rather than all the way at once while checking stacked paper alignment.
- b) In case of paper jam frequently occurs on stacker
Set the standard on the positioning gauge for the pole guide shown on the stacking table and move the pole guide to the right (to broaden the gap between pole guide and collated paper). Move the right and left side guides uniformly outward (to broaden the gap between pole and paper) based on the positioning gauge. Adjust the positioning guides gradually rather than all the way at once while checking stacked paper alignment.

5.1.4 Collation

- (1) Press the **CHECK** key for trial paper feed. The feed tables will automatically rise and each will feed one sheet of paper (set of collated sheets). Make sure there is no error in the direction and order of pages and no feeding error.

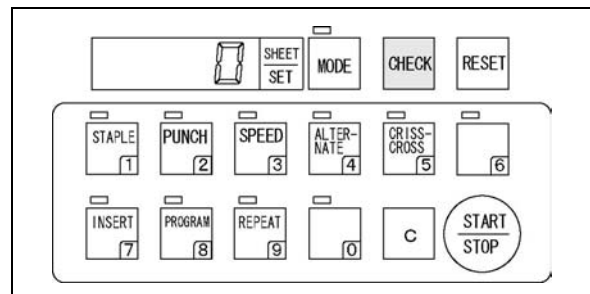

(2) If all is in order, press the **START/STOP** key to begin collating.

To halt collation, press the **START/STOP** key again.

Remarks

- a) Do not turn off the power switch while paper feed is in progress.
- b) If there is any empty feed, the last collated set may have missing pages. Add the missing pages. The collated set with missing pages will not be counted.

Note

- a) If the last sheet remains on a feed table, place several blank sheets under the remaining sheet.
- b) In case delivered paper is not properly stacked, refer to “5.1.3 Setting of stacking tables, poles, etc.” and make adjustment according to it.

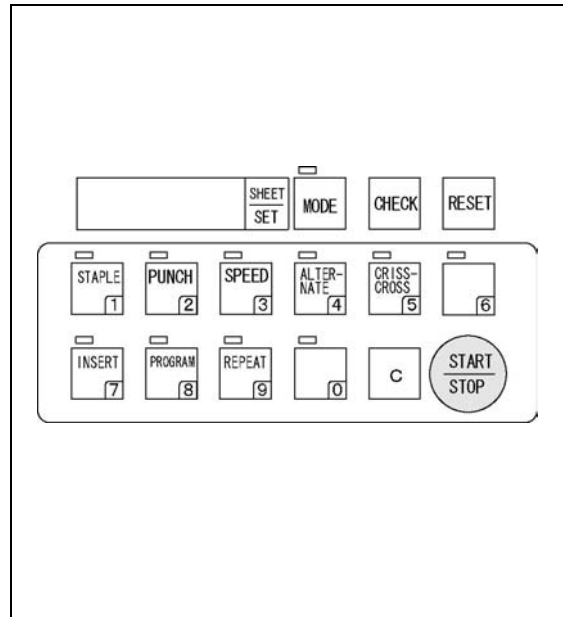

5.2 Counter

5.2.1. Using adding mode

Normally, the counter operates in adding mode. Press the **START/STOP** key to start collating and the machine will stop after all collated sheets are delivered.

The counter displays the number of collated sets and it will automatically stop when its displayed figure becomes [9999]. Press the **START/STOP** key to continue collating, and the counter will display [0] and resume counting in adding mode.

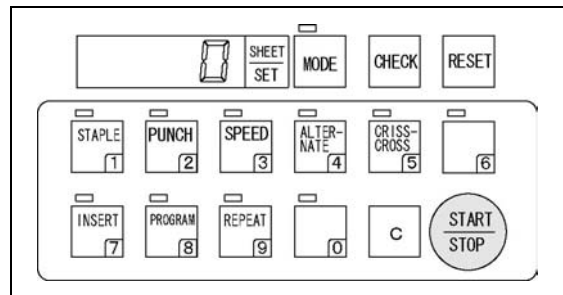

5.2.2. Using subtracting mode

Set the number of sets to be collated by pressing numerical keys.

If the number of sets is set by pressing numerical keys, the subtracting mode lamp will automatically light up.

The counter will automatically stop when its displayed figure becomes [0]. If the **START/STOP** key is pressed while the machine is in operation, the machine will stop and the counter will show the number of sets remaining to be collated.

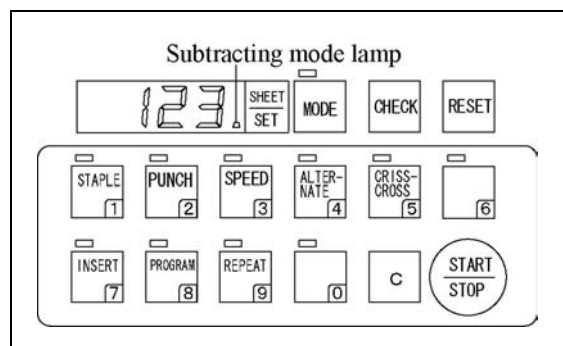

5.3 Setting collation speed

Collating speed can be set according to paper size and quality.

With the power on, it is automatically set for high speed.

- (1) Select function mode by pressing the **MODE** key. (**MODE** lamp will light).

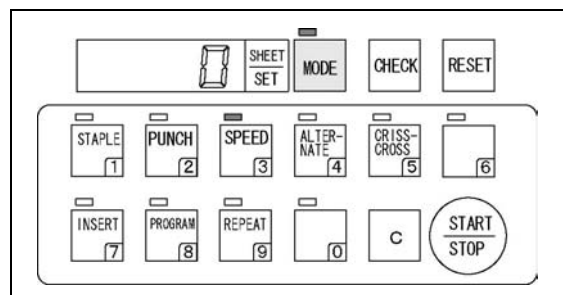

(2) Press the **SPEED/3** key to change speed. Each time the **MODE** key and **SPEED** key are pressed, speed switches between high and low speed.

(High speed: **SPEED** lamp lights; low speed: **SPEED** lamp not lit.)

Remarks

When revising collating speed, be sure to press the **START/STOP** key after pressing the **CHECK** key. The collator will not restart unless the paper is checked again.

Note

- a) If paper is improperly set on the stacking table, select low speed for proper stacking.
- b) As for setting of processing speed, the speed applied at the time when the power supply is cut off is stored in it, the machine will start operation based on that speed the next time it will be used.

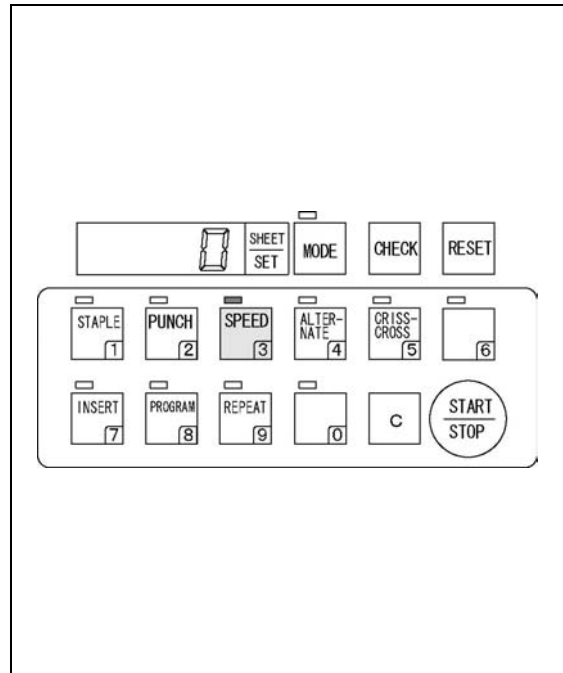

5.4 Setting normal or alternate collation mode

When collating fewer pages for many sets, Alternate mode is convenient as it loads sheets with the same page number in two neighboring stations. One machine can collate paper with up to five pages at once.

With the power switched on, normal mode is automatically programmed.

(1) Select Program mode by pressing the **MODE**. (**MODE** lamp will light).

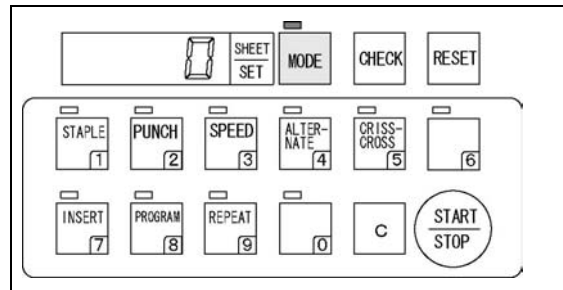

(2) Press the **ALTERNATE/4** key for Alternate mode.

Each time the **MODE** and **ALTERNATE/4** keys are pressed, the mode switches between them.

(Alternate: **ALTERNATE** lamp will light; Normal: **ALTERNATE** lamp not lit.)

Note

- a) In normal mode, up to 350 sheets per page can be loaded on each station.
- b) In Alternate mode, up to 700 sheets per page can be loaded on each station. (In case of 64 g/m² stock)

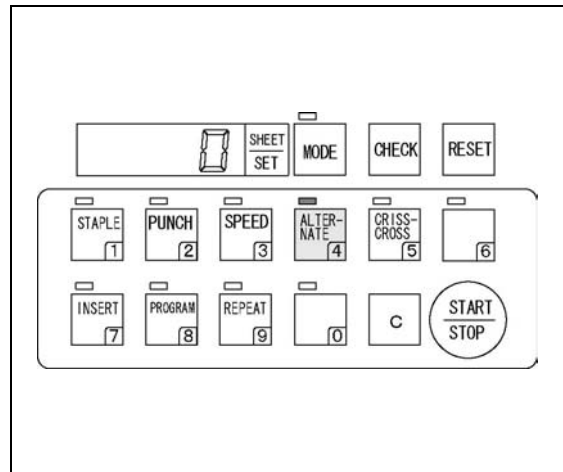

(3) Load paper in Alternate mode

- Load paper with printed side up on odd and even-numbered stations, that is, Stations 1 and 2, 3 and 4, 5 and 6, 7 and 8, 9 and 10. Paper feed starts with the odd-numbered station; if it runs out of paper, the neighboring even-numbered station will automatically start feeding.

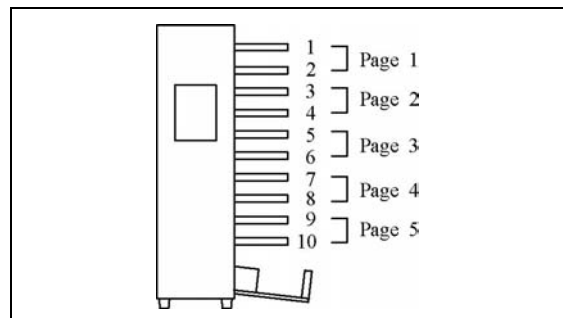

- Loading paper with the printed side down in Alternate mode.

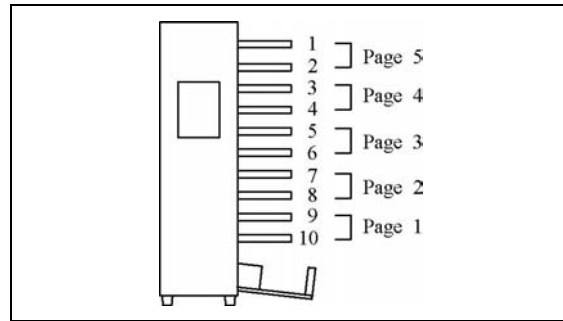

5.5 Crisscross stacking (or straight stacking)

Crisscross stacking or straight stacking can be set according to purpose.

Crisscross stacking: Collated paper is stacked set by set crisscrossed to right and left sides. (when the lamp is lit)

Straight stacking: Collated paper is stacked straight. With the power on, crisscross mode is programmed.

- (1) Select Program mode by pressing the **MODE** key. (the **MODE** lamp will light)
- (2) Press the **CRISSCROSS/5** key to switch between the two stacking modes. Each time the **MODE** key and the **CRISSCROSS/5** key are pressed, the mode switches between the two stacking modes.

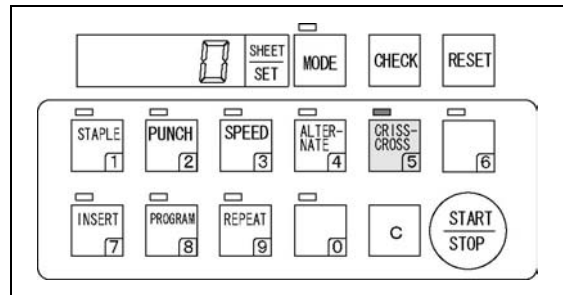
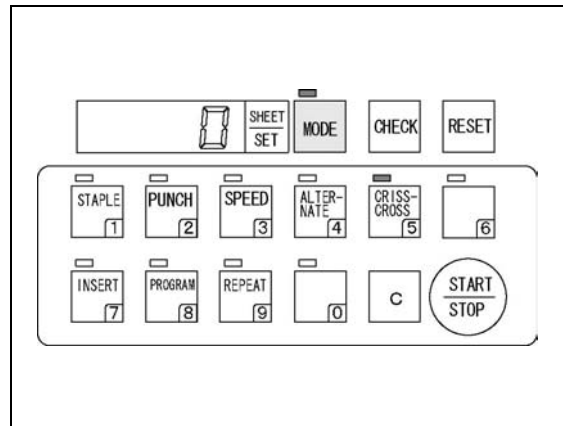

5.6 Insert mode

Insert mode serves to insert partitioning sheets loaded on the top station in use according to the predetermined numbers of sets. It is convenient for distributing similar booklets to various sections or departments.

- (1) Select function mode by pressing the **MODE** key. (the **MODE** lamp will light)
- (2) Press the **INSERT/7** key for three seconds; the Counter lamp will flash. Then input the number of sets to be collated.

<Example>

When “10” is input as the number of sets (right drawing), partitioning sheet is inserted in each 10 collated set.

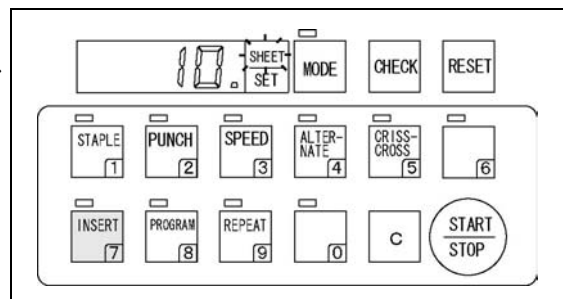
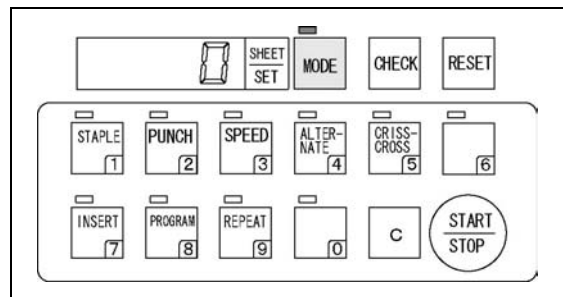

- (3) Press the **MODE** key to change the display beside the Counter from SHEET to SET, then input the number of batches.

<Example>

When “5” is input as the number of batches, the machine stops operation after 5 batches of 10 collated sets are processed.

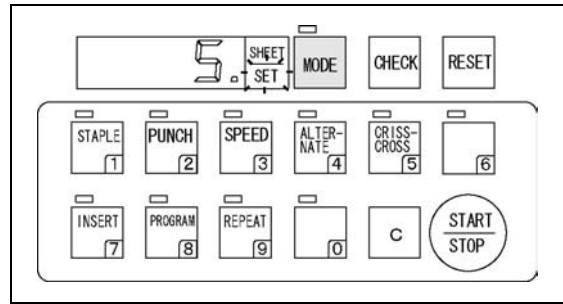

- (4) Press the **MODE** key again; the Counter will light to show the number of sets input previously.

Note

- If **0** is input as the number of batches when **SET** lights on, insert mode collation will continue until the station runs out of paper.
- To confirm the number of batches, keep pressing the **MODE** key in Insert mode; this will display the figure.
- Two or more Insert mode data can be stored. For details, see 5.8 “Storing Insert/Chit mode data.”

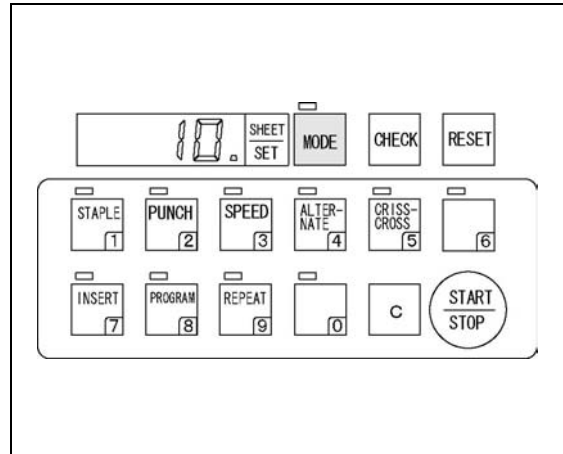

- (5) Setting partitioning paper
Load partitioning paper on the top station to be used. For instance, if 10 stations are used continuously top to bottom, partitioning paper should be loaded on Station 1.

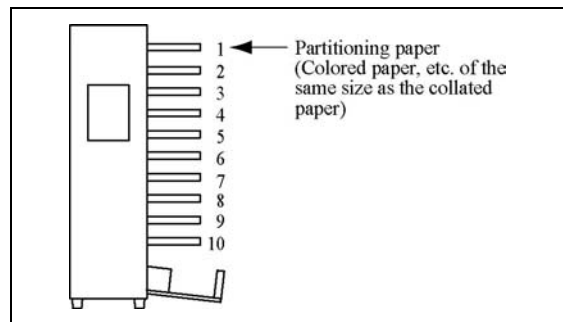

5.7 Programmed insert mode

Programmed insert mode functions to insert front covers loaded on the top station and back covers on the bottom station according to a predetermined number of sets, making it easy to prepare chits.

- Select the mode by pressing the **MODE** key. (**MODE** lamp will light)
- Press the **PROGRAM/8** key for three seconds; the Counter lamp will flash. Then, input the number of sets to be collated.

<Example>

When “10” is input as the number of sets, front and back covers are inserted in each batch (10 collated sets) of set.

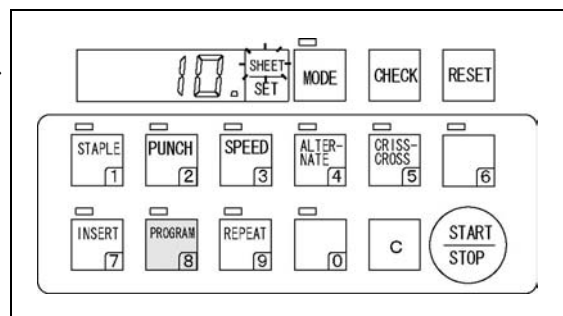
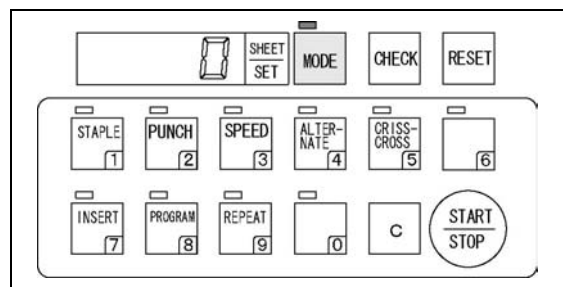

- (3) Press the **MODE** key to change the display beside the Counter from SHEET to SET, then input the number of batches.

<Example>

When “5” is input as the number of batches, the machine stops operation after 5 batches (5 chits) are processed.

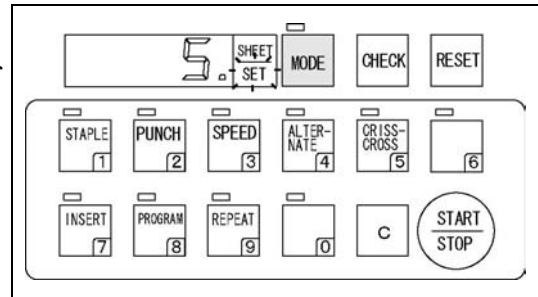

- (4) Press the **MODE** key again; the Counter will again light showing the number of sets previously input.

Note

- If “0” is input as the number of batches while SET is selected, programmed insert mode collation will continue until the station runs out of paper.
- To confirm the number of batches, keep pressing the **MODE** key in programmed insert mode; this will display the figure.
- Two or more Chit mode data can be stored. For details, see 5.8 “Storing Insert/Programmed Insert mode data.”

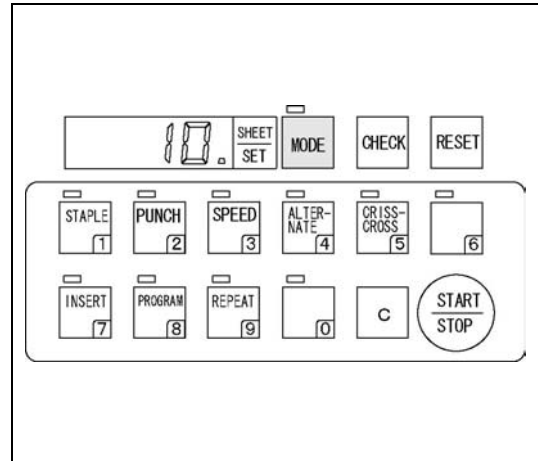

- (5) Setting front and back covers

Load partitioning paper on the top station to be used. For example, when 10 stations to be used continuously top to bottom, front covers should be loaded on Station 1, back covers on Station 10. If fewer than 10 stations are used, load front covers on the top station, back covers on the lowest of those to be used.

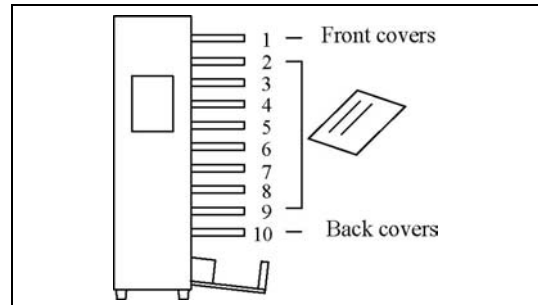

5.8 Storing Insert/Programmed Insert mode data

Up to four memories, Insert and Programmed Insert mode data can be stored.

- (1) Select Program mode by pressing the **MODE** key. (**MODE** lamp will light)

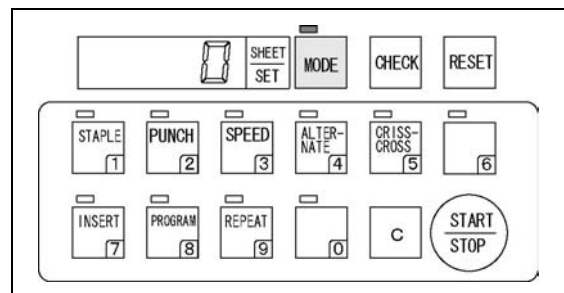

(2) Press the **MODE** key for three seconds; memory code [AbCd] will be displayed.

- A flashing letter means that that letter is not stored in memory.
- A lit letter means that that letter is already stored in memory.

The content of Insert or Programmed Insert mode data cannot be checked directly from this; it should be checked by calling up the data, as explained in 5.9 “Calling up Insert/Programmed Insert mode data.

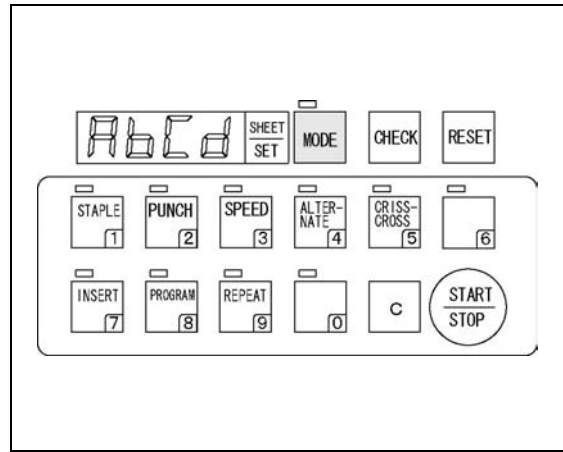

(3) Press the key responding to A to d for three seconds and memorize the data.

Memory code A to d responds to the following keys:

- Memory code A: Key 1
- Memory code b: Key 2
- Memory code C: Key 3
- Memory code d: Key 4

To cancel the storage in each memory code, press the **RESET** key.

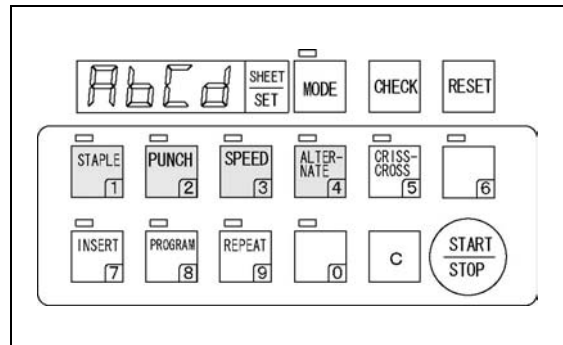

5.9 Calling up the Insert/Programmed Insert mode data

(1) Select Program mode by pressing the **MODE** key.

(**MODE** lamp will light)

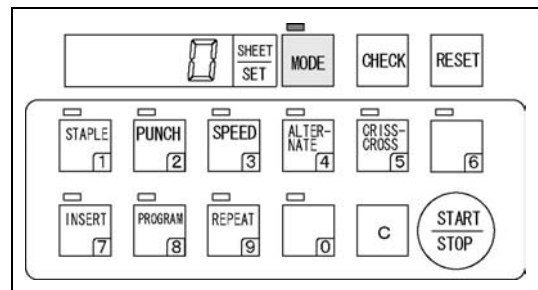

(2) Press the **PROGRAM** key for three seconds; memory code [AbCd] will be displayed.

- A flashing letter means that that letter is not stored in memory.
- A lit letter means that that letter is already stored in memory.

Remarks

- To check the content of Insert or Programmed Insert stored memory data directly requires calling up the data content once.

See 5.6 “Insert mode” and 5.7 “Programmed insert mode.”

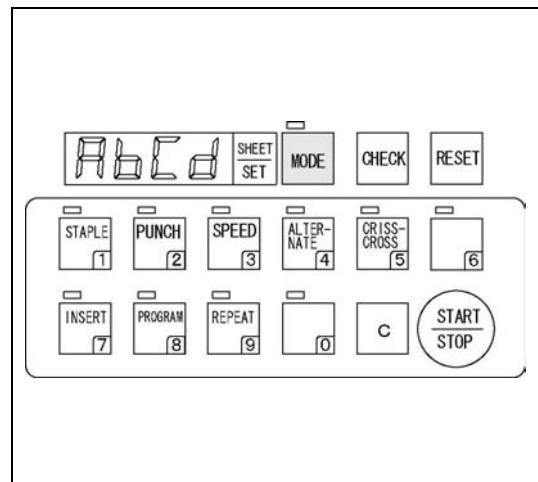

(3) Press the key to respond to A to d for three seconds and memorize the data.

Memory code A to d responds to the following keys:

- Memory code A: Key 1
- Memory code b: Key 2
- Memory code C: Key 3
- Memory code d: Key 4

To cancel the storage in each memory code, press the

RESET key.

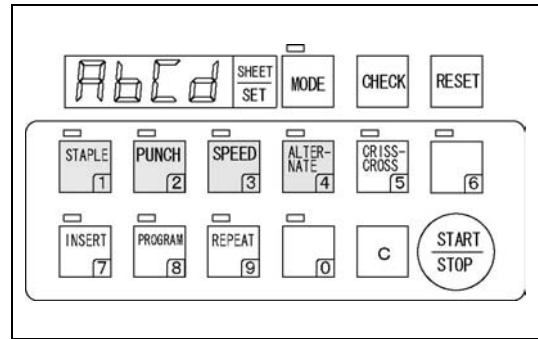

5.10 Repeat mode

Repeat mode is a function to set crisscross mode according to the number of sets, making it easy to file only part of a chit book.

(1) Program the number of sets to be stacked with crisscross stacking.

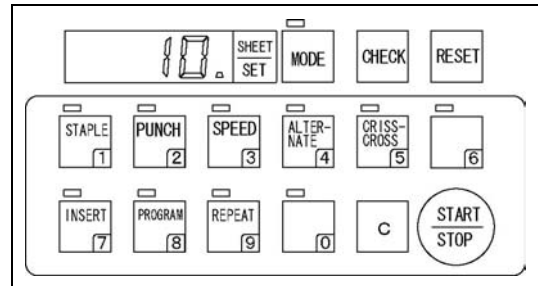

(2) Press the **MODE** key to switch to Function mode.

(**MODE** lamp will light)

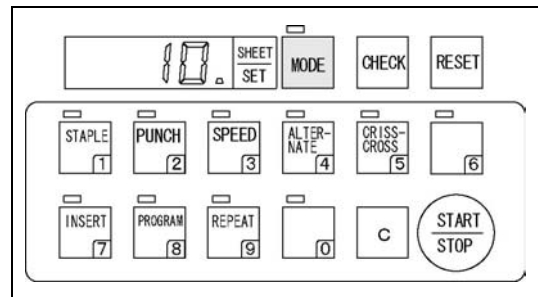

(3) Press the **REPEAT/9** key; the **REPEAT/9** lamp will light.

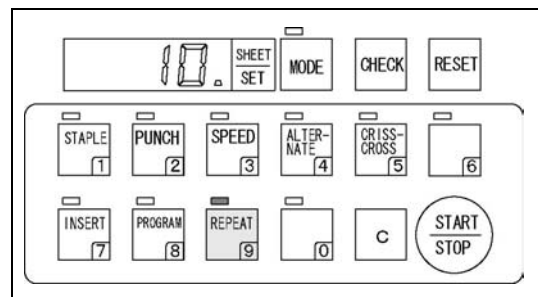

5.11 Changing light intensity

Each time paper is checked, the machine detects paper thickness and automatically adjusts the intensity of light it emits using the photo sensor. But if the light intensity initially set is too bright, the photo sensor may judge empty feed when very thin paper is fed, as the light is too strong and the sensor cannot detect the paper. In this case it is necessary to manually reprogram the intensity of light emission.

To reset light intensity, the value of system constant “P” must be changed.

Note

When paper check is repeated several times, the photo sensor will automatically adjust the light intensity to suit paper thickness.

5.11.1 Changing system constant “P”

- Press the **0** key for three seconds to switch to system programming mode; [P “X”] will be displayed on the Counter (one of 1 to 9, A, b, C, d, E, F will be shown on “X” as the present set value).

19 types can be programmed as a system constant according to the following sequence of the intensity.

WEAK **STRONG**
 <1, 2, 3, 4, 5, 6, 7, 8, 9, A, b, C, d, E, F>

- **PROGRAM** key: Move to the next item
- **RESET** key: Return to the previous item
- **CHECK** key: Temporarily modified and finished
- **START** key: Stored and finished.

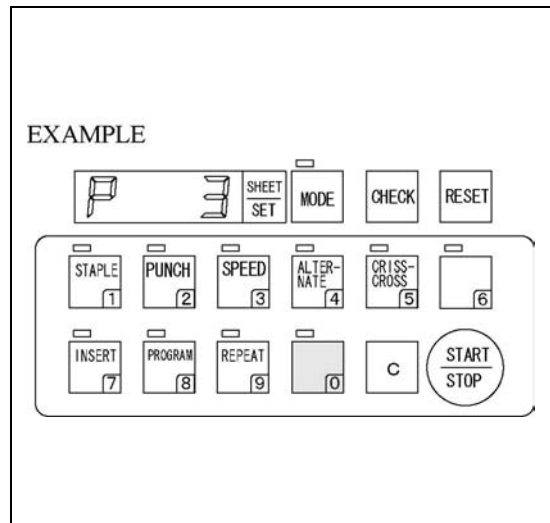

- Press **4** key to increase intensity by one degree; press **0** key to reduce it by one degree.

Note

- The value set at the time of factory shipment is between 3 and 4.
 (Adjusted based on 64g/m² stock)

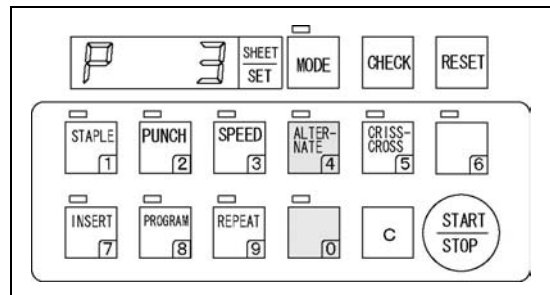

- Press the **START/STOP** key to store the changed value.

Note

- If the operation is finished after pressing the **START/STOP** key, the programmed value will be stored even if the power is turned off.

If the operation is finished after pressing the **CHECK** key, the value will return to the value prior to the change.

When changed temporarily, press the **CHECK** key and pass the system constant programming mode.

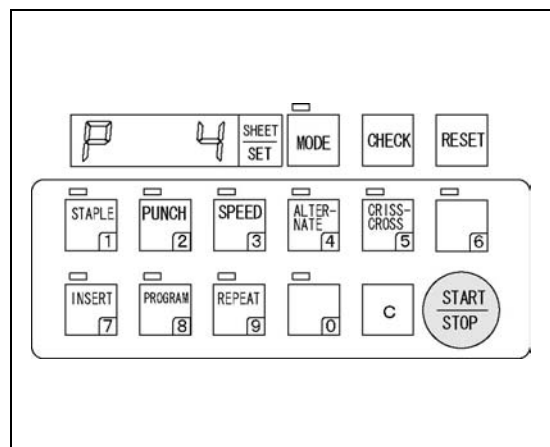

6. MAINTENANCE, INSPECTION, CONSUMABLES

6.1 Important for maintenance and inspection



When conducting inspections and maintenance, be sure to remove the power plug from the outlet. If not, it may cause injury or electric shock.

6.2 Usual maintenance

- Cleaning of paper feed rubber roller and separator is recommended from time to time (as required).

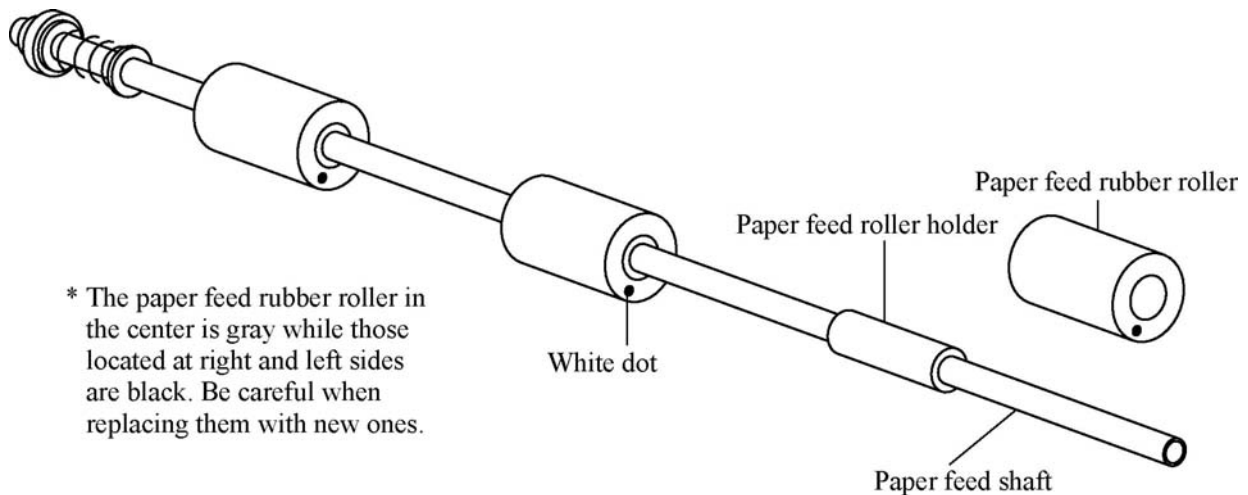
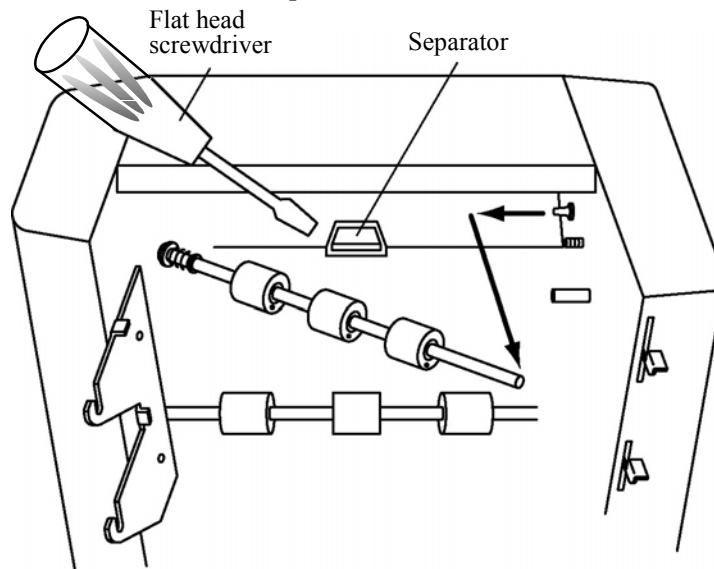

- (1) Remove the paper feed tables and auxiliary tables. While holding the paper feed shaft, push it in to the left, then pull it toward the front. If the paper feed rollers are dislocated, correct their positions; the center rubber roller should be located at the center of the separator.
- (2) After removing the paper feed shaft, clean its three rubber rollers using a cloth dampened with cleaning fluid special for the collator (option). Clean the separator too, leaving it mounted on the machine while doing so.
- (3) Install the paper feed shaft in the way reverse to how it was removed.

 **Note**

Should trouble such as double feed, no feed, etc. occur after cleaning, the rubber paper feed rollers and separator are worn. Replace them with new ones referring to the previous page. When the paper feed rubber rollers are replaced, mount them on the paper feed rollers holders so that the white dot of the rubber rollers is on the right-hand side. In addition, after mounting the paper feed rollers on their holders, roll them on a flat surface such as a desktop to make sure they are mounted horizontally. If mounted askew, problems like paper feed failure or double feed may occur. Use a flat head screwdriver to remove the separator. Be watchful of the paper detection wire when replacing the feed rollers.

- Cleaning the exterior
Wipe off any stains using a damp cloth.

Remarks

Do not use solvent cleaning liquids as they may cause discoloring.

6.3 Consumables

The collator's paper feed rollers (CU 145231) and separator rubber (UC 145181) are consumable. Contact your dealer when they need replacing.

7. TROUBLE SHOOTING

7.1 Corrective actions to be taken when LED lamps are lit or flashing

When **EMPTY FEED**, **PAPER JAM** or **DOUBLE FEED** lamps flash, remove the last set from the ejected paper.

Since the number of erroneous collation is not counted, the number of stacked sets is the number of sets displayed on the counter less the removed one set.

LAMPS (Lit/Flashing)	STATUS/CAUSE	CORRECTIVE ACTION
CHECK (Lit in green)	Normal operation	Stations in use and paper thickness are checked.
NO PAPER/ EMPTY FEED (Flashing in green)	If a station in use has run out of paper or an empty feed occurs, the corresponding lamp will flash. In case of empty feed, the counter will display "Err." In case of no paper, it will display "End."	Load additional paper.
		Fan out the paper well.
		Select feed pressure stronger by one degree.
		Set paper inversely.
PAPER JAM (Flashing in red)	If a paper jam occurs, the corresponding station lamp and the PAPER JAM lamp will flash. The counter will display "Err."	Fan out the paper well.
		Select separator pressure weaker by one degree.
DOUBLE FEED (Flashing in red)	If double feed occurs, the corresponding station lamp and the DOUBLE FEED lamp will flash. The counter will display "Err."	Fan out the sheets of paper well.
		Select separator pressure stronger by one degree.
		Select paper feed pressure weaker by one degree.
		Double feed may occur if a mixture of paper of different quality or differently printed paper is loaded onto a station. Be sure to load each station with paper of only one quality.
		Remove from the stacking table extra page delivered owing to double feed.
EJECT (Flashing in red)	If the stacking table is full of delivered paper or stacking paper jam occurs, the EJECT lamp will flash. The counter will display "Err."	Remove the paper that has filled the stacking table, or jammed paper, and press the RESET key.
EJECT (Lit in red)	If the paper discharge sensor is intercepted, the EJECT lamp will light and counter will display "Err."	Install the stacking table properly.
		Install the collator on a level place.
		Remove paper dust from right and left ejection sensors
DOOR (Lit in red)	The back door is open.	Close the back door. (Make sure it is firmly fixed) The DOOR lamp will flash if the back door is open while the machine is in operation. In such a case, close the back door and press the RESET key.

LAMPS (Lit/Flashing)	STATUS/CAUSE	CORRECTIVE ACTION
When paper is checked by pressing the CHECK key, STATION lamps will flash in red even if double feed has not occurred.	The light emitted by the paper feed photo sensor is too bright or too dark against the thickness of paper. STATION lamps will flash in red. Too bright: flash fast Too dark: flash slow	Repeat paper check several times by pressing the CHECK key. Each time paper check is repeated, the paper feed photo sensor will automatically adjust the intensity of the light to suit paper thickness.
When paper is checked by pressing the CHECK key, STATION lamps will flash in green even if paper feed is occurring properly.	This indicates that the light emitted by the paper feed photo sensor is extremely too bright for the thickness of paper.	Refer to “5.11 Changing light intensity” (1) Resetting photo sensor intensity to the initial value. Turn off the power switch, then turn it on while pressing the CLEAR key. (2) Changing paper feed photo sensor intensity. 1) Press the 0 keys for three seconds. Then, the counter display will indicate “P-X” showing the present light intensity of the paper feed photo sensor. 2) Press 4 key to increase intensity by one degree; press 0 key to reduce it by one degree. 3) Press START/STOP key to store the changed value.

In order to stop the flashing, press the **RESET** key.

In case lamps are lit, they will go out when the corresponding troubles are removed.

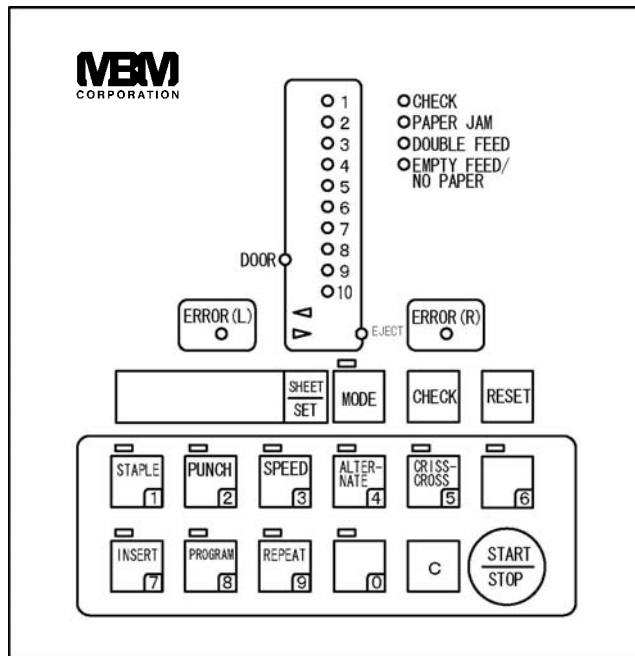

7.2 Troubleshooting

Troubles	Possible cause	Action
The POWER has been switched on, but does not indicate on the operation panel.	The power cord is not plugged in.	Insert the power plug into the outlet.
	The circuit breaker is activated.	Reset the circuit breaker.
	Internal trouble of the machine	Contact your dealer.
The [START/STOP] key has been pressed, but the machine does not work.	A paper check is required. A warning will beep and “ ” (no indication) will appear.	Press the [CHECK] key for trial feed.
The [CHECK] key has been pressed, but the machine does not work. Lamps on the operation panel light or flash, indicating irregularities.	The back door is not closed completely.	Close the door securely.
	The stacking table is full or a paper jam is occurring on the stacking table.	Remove delivered or jammed paper.
	A paper jam has occurred on station.	Remove jammed paper.
	When the stapler-puncher is in use, a paper jam or a blown fuse has occurred within the stapler-puncher, or the stapler-puncher has run out of staples.	Remove the cause of the trouble.
	Internal trouble of the machine	Contact your dealer
The machine has started operation by pressing the [START/STOP] key or the [CHECK] key, but no paper is fed.	Sheets are not set properly.	Set sheets securely on a feed table.
Paper jams on the stacking table occur frequently, or sheets are not stacked neatly.	Stacking table paper guides are not set properly.	Adjust the paper guides.
	The aligning wire is not mounted properly.	Mount the aligning wire securely.
Paper jams, double feed or empty feed occur frequently.	Paper feed rollers are dirty.	Clean the paper feed rollers.
	Separators are dirty.	Clean the separators.
	Sheets of paper are curled.	Straighten curled papers and set sheets on feed table.
	Feed rollers are worn.	Replace the rollers.
	Separators are worn.	Replace the separators. (contact your dealer)
	Paper feed tables have been attached or removed while the power switch is on.	Reset the feed tables after switching off the power.
Paper has stopped halfway.	Power supply was cut off due to power failure or other troubles.	Remove the paper by pressing the [RESET] key for more than three seconds to start the main motor.
Double feed occurs frequently.	Separator pressure is too weak.	Select stronger separator pressure.
	Paper feed pressure is too strong.	Select weaker paper feed pressure.

Troubles	Possible cause	Action
Empty feed occurs frequently.	Paper feed pressure is too weak.	Select stronger paper feed pressure.
	Separator pressure is too strong	Select weaker separator pressure.
	Sheets are curled at the edges because they were copied.	Set sheets upside down on a feed table.
Paper becomes dirty.	Paper feed rubber rollers, separators, transport belts, are dirty.	Clean the rollers, separators, and /or belts.
The EJECT lamp shows.	The stacking table is not set properly.	Set the stacking table properly.
	The machine and stacking table are not installed at level place.	Install them at level place.
	The paper ejection area of the machine are exposed to direct light.	Shade light with curtains or the like, or move the machine to a darker place so that the ejection area will not be exposed to direct light.
The collator suddenly runs fast.	The paper ejection sensor malfunctions when hands or foreign objects enter the ejection area while the machine is in operation.	Make sure that foreign objects do not enter the ejection area while the machine is in operation.
	The machine and stacking table are not installed on level place.	Install them at a level place.
	The paper discharge parts of the machine are exposed to direct light.	Shade light with curtains or the like, or move the machine to a darker place so that the ejection area will not be exposed to direct light.
The DOUBLE FEED lamp lights even after only one sheet of paper has been fed.	Paper of different qualities are loaded onto same feed table.	Make sure that sheets of the same quality are loaded onto a paper feed table.
	Differently printed paper is loaded onto same feed table.	Make sure that sheets printed in the same way are loaded onto a feed table.
	Paper not conforming with specifications is in use.	Use paper conforming with specifications.
Lamps for stations repeatedly lights up and go out while moving up and down.	Troubles in the table lifting motor or other electrical parts	Contact your dealer.

7.3. In case of breakdown

Should the collator need repair, contact your MBM dealer.

8. RELOCATION OR DISPOSAL

8.1 Relocation

8.1.1 Removal of the machine from its present location

Before removing the machine from its present location, be sure to remove the power plug from the wall outlet.

8.1.2 Transport

- (1) Transport the removed parts, attachments and Operation Manual together with the machine.
- (2) Take care not to expose the collator to strong vibration or shock.

8.1.3 Installation

When installing the collator at its new location, observe the same procedure as when first installing it.

8.2 Disposal

When disposing of the collator, ask a contractor specialized in industrial waste disposal to handle it in accordance to the local regulations.

9. PRODUCT SPECIFICATIONS

9.1 Specifications

Stations	10 stations
Paper Feed	Roller separator system
Station Capacity	1.1" (approx. 350 sheets of 64g/m ² paper)
Paper Transport	Belt roller system
Stacking Capacity	2.6" (approx. 880 sheets of 64 g/m ² paper)
Paper Stacking System	Right and left index system (20° apart) or straight stacking
Speed	40-60 set/minute (8.5" x 11" size paper) selectable
Max. paper Size	12.9" x 18.5"
Min. paper size	3.8" x 5.9"
Paper quality	1st and 10th station: 35 to 210 g/m ² 2nd to 9th station: 35 to 160 g/m ²
Detection of Station in use	Stations in use can be checked by trial feed programmed by CHECK key.
Detection of Paper Quality	Paper thickness on each station can be checked by trial feed programmed by CHECK key.
Feed Error Detection	Empty feed, no paper, paper jam, double feed (detection of paper thickness with photo-electric sensors)
Other Detection	Stacking table full, paper eject jam, back door open/close status, (Staple cartridge empty and paper jam detection when optional stapler-puncher is mounted).
Additional Features	<ul style="list-style-type: none"> - Automatic elevation of paper feed table - Alternate collation (Neighboring two stations can be used together for the same sheet/page. - Insertion of partitioning paper (according to the designated set) - Programmed insertion of cover paper (loading covers on the top station and back covers on the bottom: Good for collation for system-notebook, chits, etc.) - Three levels of paper feed pressure (four levels for Station 1 and 10, and three levels for Station 2 to 9) - Three levels of separator pressure (Fourth level built-in while not displayed on the tablet: Used for special papers) - Four-digit display on the operation panel counter, addition/subtraction (preset) switch-enabled
Power Supply Voltage	AC120V 60Hz
Power Consumption	200W
Dimensions	21.5"W x 29.6"D x 41.6"H
Weight	167.5 lbs

Specifications are subject to change without prior notice for the sake of improvement.

9.2 Optional parts

Part Name	Qty	Figure
Auxiliary paper guide right assembly Auxiliary paper guide left assembly	10 each	<p>Auxiliary paper guide right and left assemblies</p> 



P.O. Box 40249
North Charleston, SC 29423
800-223-2508, fax: 843-552-2974
www.mbmcorp.com