

Operation
Manual

VBV
CORPORATION

StitchFold Bookletmaker

Bookletmaker

CONTENTS

Introduction	3
Specifications	3
Safety	4
Assembly Drawing	5
Installation	6
Preventive Maintenance	6
Control Panel	7
Fuses	7
Operation & Setup	8
Side Stitching.....	9
Corner Stitching.....	10
Adjustments	11
Trouble Shooting.....	12

INTRODUCTION

Simple Operation: Just load your booklet and it is automatically jogged, stitched, folded, and discharged onto an accumulating output conveyor. Side stitching, corner stitching, and folding projects, with or without stitching, are easily accomplished.

Advanced Technology: *StitchFold* uses patented magnetic stitching head technology, providing the reliability and economy of wire stitching. Dual sets of folding rollers assure consistent, professional results. For safety, interlocked access guards prevent machine operation when open.

Improved Productivity: With *StitchFold*, you can jog, stitch, and fold more than 65,000 booklets at a maximum speed of 2,300 finished booklets per hour - without stopping to reload staples. *StitchFold's* variable work thickness capacity handles from 2 sheets to a one hundred page booklet with no setup changes or adjustments.

Lower Operating Costs: The *StitchFold* replaces expensive preformed staples with inexpensive bookbinding wire; you save on material costs and nonproductive downtime.

BOOKLETMAKER SPECIFICATIONS

Unit Weight:	250 Pounds
Speed:	Up to 2,300 booklets per hour
Capacity:	2 to 25 sheets of 20# bond (.100" thick before folding) (100 page book)
Re-load:	65,000 booklets per spool of wire
Paper Size:	Min. 4.75" x 8.25" Max. 12.75" x 18.5" (also: A5 to A3)
Booklets:	4.25" x 5.5", 5.5" x 8.5", 8.5" x 11", 4.75" x 4.75 "CD", & metric sizes (All booklets with or without trim stock on one or three sides)
Stitch Space:	5.5" on 8.5" or 11" tall books 2.75" on 5.5" tall books
Counter:	Resettable 6-digit electronic counter
Folder:	Knife folder with dual folding rollers
Squaring:	Side jog plus full length tape feed
Output:	Continuous conveyor
Footprint:	16.25" x 22.5"
Dimensions:	Height 25" Width 21" Depth 52"
Modes:	Stitch and Fold, Stitch, Fold, Corner Stitch, Side Stitch
Electrical:	Standard outlet - 115 Volts, 60 Hz, 10 Amps (1/4 HP)

SAFETY

SAFETY PRECAUTIONS AND PROCEDURES

1. Make sure electrical power is turned off before performing any adjustment or maintenance.
2. Keep hands, hair, tools, and clothing clear of stitching area.
3. Become familiar with the moving components of your machine. Keep fingers away from areas that could pinch or cut.
4. A well maintained machine is a safer machine. Clean and lubricate the machine at regular intervals. Check machine daily for broken or worn parts. Replace as necessary. DO NOT attempt to operate the machine if a part is broken.
5. See "SAFETY GUARDS" below! If you are unsure how to safely operate your Bookletmaker, contact your Service Representative.



KEEP HANDS CLEAR OF STITCHING AREA AND ANY MOVING PARTS!

NEVER OPERATE MACHINE WITHOUT ALL GUARDS IN PLACE!

SAFETY GUARDS

- A. Front Guard: Blocks access to the stitching heads and their point of operation. An electrical interlock keeps the machine turned off unless this hinged guard is closed. Do not stick your fingers under the front guard!
- B. Top Guard: Blocks access to mechanism that drives the stitching heads. An electrical interlock keeps the machine turned off unless this guard is closed. Do not stick your fingers under the top guard!
- C. Right Side Cover: Blocks access to mechanisms that can pinch or cut.
- D. Left Side Cover: Blocks access to dangerous electric voltage and mechanisms that can pinch or cut. Be sure to disconnect electrical power before removing this cover.
- E. Front Cover: Blocks access to dangerous electric voltage and mechanisms that can pinch or cut. Be sure to disconnect electrical power before removing this cover.
- F. Rear Cover: Blocks access to low voltage connections and mechanisms that can pinch or cut. Do not stick your fingers beyond this cover!
- G. Roller Guard: Blocks access to a pinch points. Do not stick your fingers beyond this cover!

ASSEMBLY DRAWING

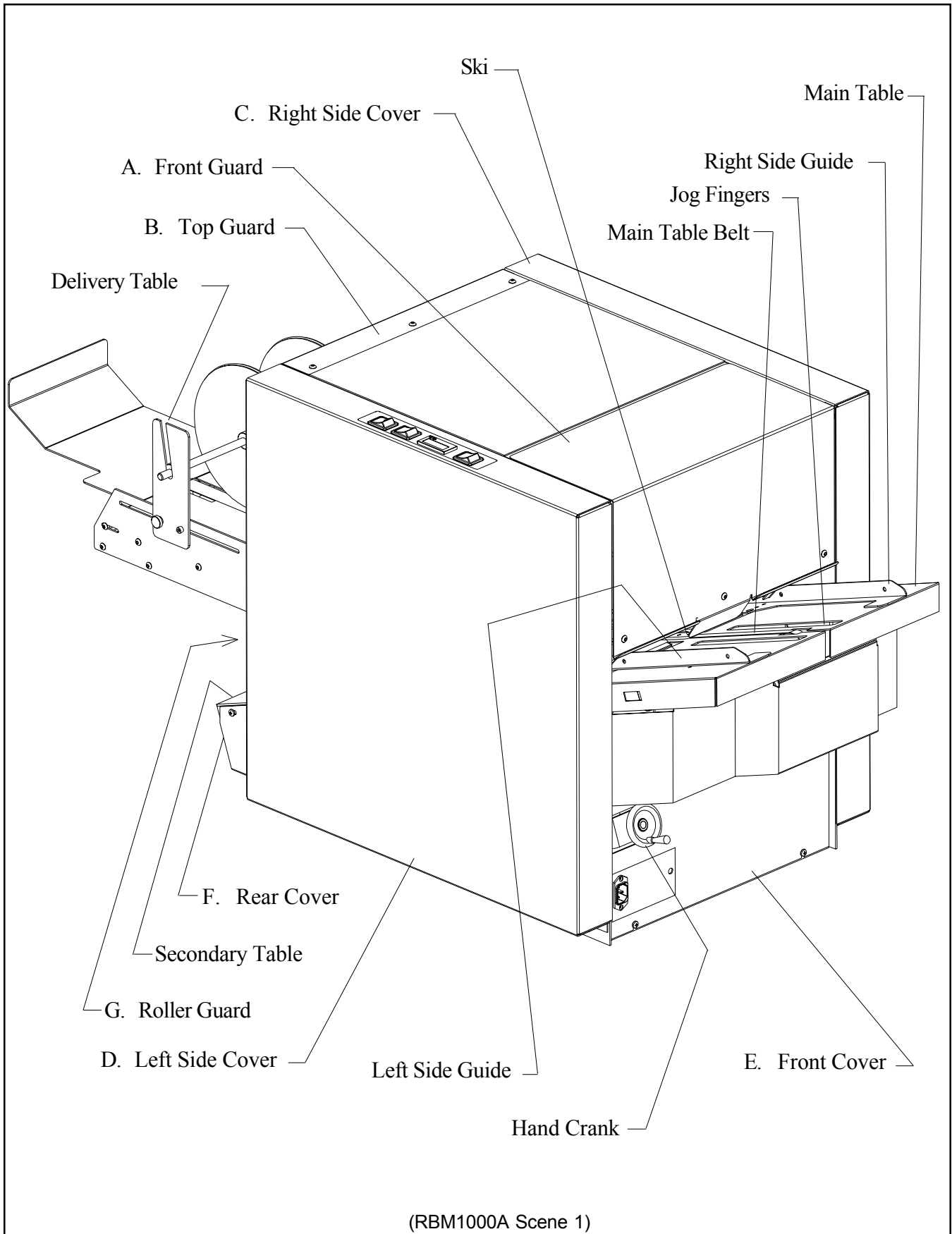

StitchFold

INSTALLATION

BEFORE UNCRATING:

Examine the crate for visible damage. If the crate is damaged, the machine might be damaged. Notify the carrier who delivered the machine.

UNCRATING THE MACHINE:

Carefully remove the machine from its container. Lift the machine by grasping its strong framework. Tugging on cables, covers, or other delicate components could cause damage.

Examine the machine for damages incurred during shipping. Do not install a damaged machine. Notify the carrier immediately, and be sure to get a signed copy of the Carrier Inspector's Report of the damage incurred. Your service representative will assist you in determining the cost of repairs.

ELECTRICAL POWER:

The power cord can be plugged into any 115V, 60 Hz, 1 Phase, 15 Amp circuit. The machine draws less than 10 amps.

LOADING & THREADING WIRE:

Use only approved stitching wire, part number 415-0225. Open the top guard to reach the wire spool studs. Remove the first retaining pin on each stud. While holding back the white brake pad, mount the coil of stitching wire so the wire comes off upward from the backside, and replace the pin.

Thread the wire upward through the large opening in the spring lever assembly, over the curved section of the lever, and through the slot in the lever. Continue to thread the wire over the large roller on top of the stitcher head, through the straightening rollers, into the check pawl, and down past the gripper. (For easier threading, temporarily turn straightening roller to "OFF" position.) Guide the wire about 1/8" into the hole in the top of the cutter.

When both heads are threaded, the machine is ready to operate. However, it will take two cycles before proper stitches are produced. See instructions in the stitching head owners manual for detailed instruction on threading wire.

PREVENTIVE MAINTENANCE

LUBRICATION:

Disconnect electrical power. Next, remove the front cover and both side covers.

Use SAE-20 oil to lubricate porous bronze bearings, plastic bearings, chains, and shafts.

Use approved stitcher head lubricant, part number CA9640, to lubricate the stitching heads every time a new coil of stitching wire is loaded. Clean and lubricate the magnetic rotator. Lubricate the driver bar and the bender bar latch. See stitching head owners manual for detailed lubrication instructions.

CLEANING:

Use MBM Roller Wash (#0735) to clean the belts.

Use MBM Roller Wash (#0735) to clean the folding rollers.

MAIN CONTROL PANEL

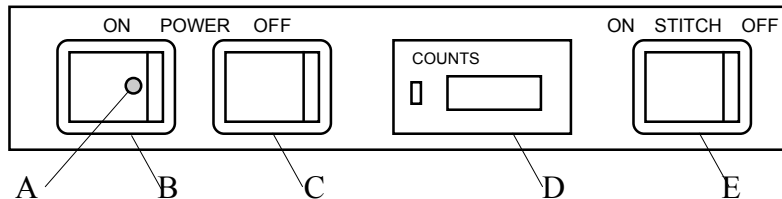

- A. Pilot Light: Glows to indicate that electrical power is turned on.
- B. Power On: Black rocker switch turns on power. Pilot glows, motor runs, and belts move.
- C. Power Off: Red rocker switch turns off power.
- D. Counter: Digital counter records the number of sets that pass through the machine. A manual reset button returns the counter to zero after each job. The reset button can be locked to prevent accidental reset.
- E. Stitch On/Off: Selector switch chooses mode of operation: "On" for stitching jobs or "Off" for folding without stitching.

Note: Opening the front or top guards shuts off the machine. It must be restarted as above.

FUSE PANEL



Lift open the front guard. The fuse panel is located on the left side wall. Use a small screw driver to open each fuse holder.

- A. Main Fuse: Fuse protects entire machine. If this fuse fails, power cannot be turned on. Replace with 10 amp ceramic time-delay fuse, #RBM1239F.
- B. DC Fuse: Fuse protects transformer. If this fuse fails, none of the 24VDC components will operate. Replace with proper .75 amp fuse, #RBM1267F.

StitchFold

OPERATION & SETUP

BOOKLETMAKING

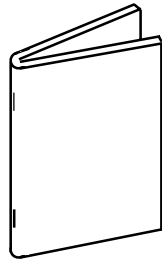

STITCHING HEADS:

Make sure the stitching heads are mounted in the proper positions to match the paper size. For 5.5" x 8.5" (also A5) paper, the heads must be mounted in the two positions closest to the belt on the main table. One head is mounted just to the left of the belt, and the other head is mounted just to the right of the belt. These head locations will provide a stitch spacing of 2.75". For 8.5" x 11" or 11" x 17" (also: A4 or A3) paper, each head is mounted in the second position to the left and the right of the center belt. These head locations provide 5.50" stitch spacing.

To move a stitching head to a new position, first lift open the top guard. Loosen and remove the knob/bolt from the back of the head. Pull the head forward until it comes off of the locating pin, and slide it over to the desired location. Slip the head onto the new locating pin, and be sure that the driving lug on the upper backside of the head engages the slot in the head driving bar. Replace the knob/bolt (and its washers and lockwasher), and tighten it securely.

PAPER WIDTH:

Adjust the side guides for paper width. For instance, if 8.5" x 11" paper is being used to make a 5.5" x 8.5" booklet, the side guides must be set for the 8.5" width. First, lift open the front guard. Loosen the thumb screw on each side guide, and slide each guide sideways until its outer edge is aligned with the 8.50" mark on the setup scale. This adjustment is critical for accurate stitch placement, so fine tune as follows. Place two sheets of paper between the side guides and slide them under the ski until they stop against the first gate. Hold the right side guide with your fingers on each side of the thumb screw

and pull it to the left until it stops at the fully jogged position. In this position, the paper must fit perfectly between the side guides. If there is a gap or the paper buckles, loosen the thumb screw on the right-hand side guide and move it in the correct direction. Recheck your side guide position until proper setting is obtained.

PAPER LENGTH:

Adjust the gates for paper length. For instance, for 8.5" x 11" paper, the gates must be set for the 11" length. Place two sheets of paper between the side guides and slide them under the ski until they stop against the first gate. While holding the paper against the gate, turn the hand crank under the left hand side of the table until the paper is aligned with the 11" mark on the scale. (Clockwise rotation moves the paper out.) This single adjustment takes care of the stitching gate, the folding gate, and the optional back jog.

For machines equipped with the optional back jog, fine tune the hand crank adjustment as follows. Place your finger about one inch down from the top of one of the jog fingers and raise it to the point that it hits the stop. Use your other hand on the hand crank to get the two sheets firmly against the back jog finger without buckling the paper. In other words, two sheets should fit perfectly between the first gate and the raised jog fingers.

Adjust the booklet tray at the end of the delivery table to match the booklet size. Loosen the knob under the tray, and slide the tray to the proper position. Finally, adjust the position of the delivery table wheels. There are four sets of slots in the frame for positioning the shaft and wheels; choose a position that suits the booklet size. Just lift the shaft and wheels and set the ends of the shaft into the appropriate pair of slots.

OPERATION:

Turn on power and select "STITCH ON". Square up a set of paper sheets by hand, and lay the front edge on the table between the side guides. Push until the front edge is under the ski, and then let go. The set will be automatically stitched, folded, and ejected onto the output conveyor.

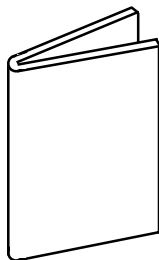
FOLDING ONLY

Adjust the machine for paper size according to the instructions for bookletmaking. However, the stitching heads may be left in any mounting positions. On the control panel, select "STITCH OFF".

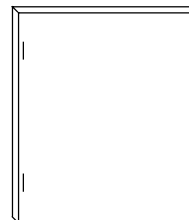
SIDE STITCHING

Side stitching can be done with 5.5" x 8.5" or 8.5" x 11" (also: A4 or A5) paper. In either case, mount the heads for 5.50" stitch spacing.

Lower the folding gate by pressing the toggle switch located on the secondary table. The side stitched sets will drop off the end of the secondary table unfolded. The booklet stacker assembly can be relocated to catch the finished sets.

Adjust the side guides for paper length. For instance, if 8.5" x 11" paper is being side stitched, the side guides must be set for the 11" length. Align the outer edge of each side guide with the 11" mark on the table scale.

With Optional Side/Corner Stitch Gate:

Use thumb screw to mount gate assembly on the middle of the stitcher head mounting bar. Connect cord from gate to socket on left inside wall. Place two sheets between the side guides, and slide them under the ski until they stop against the side stitch gate. Use the hand crank to adjust the position of the back jog until the paper just fits between the gate and the raised jog fingers. If the standard fold gate returns early and causes a jam or double stitch, turn the gate timer clockwise enough to prevent the problem.

Without Optional Side/Corner Stitch Gate:

Adjust the stitching gate for paper width. For instance, for 8.5" x 11" paper, the gate must be set for the 8.5" width. First, lift open the front guard. Place two sheets between the side guides, and slide them under the ski until they stop against the gate. Turn the knob until the trailing edge of the paper is just in front of the clinchers.

StitchFold

CORNER STITCHING

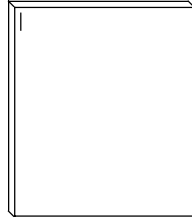

Lower the folding gate by pressing the toggle switch located on the secondary table. The side stitched sets will drop off the end of the secondary table unfolded. The booklet stacker assembly can be relocated to catch the finished sets.

With Optional Side/Corner Stitch Gate:

Corner stitching can be done with 5.5" x 8.5" or 8.5" x 11" (also: A4 or A5) paper. In all cases, mount one head in the far right position. (Be sure there is a clincher in the far right position. If necessary, relocate the far left clincher to the far right position.) The other head may be removed or left in another position without wire. Use thumb screw to mount gate assembly on the middle of the sticher head mounting bar. Connect cord from gate to socket on left inside wall.

Adjust the left side guide for paper length. For instance, if 8.5" x 11" paper is being corner stitched, the side guide must be set for the 12" length. Align the outer edge of the left side guide with the table scale as follows:

11" paper	12" mark
8.5" paper	7" mark
A4 paper	13.4" mark
A5 paper	6.5" mark

An accessory guide must be mounted on the right hand side for corner stitching. Using thumb screws and wing nuts, attach the corner stitch guide (9" long sheet metal part) to the two holes in the right side guide.

Place two sheets between the side guides, and slide them under the ski until they stop against the corner stitch gate. Pull the right side guide left to the jogged position. If there is a gap or the paper buckles, loosen the thumb screw on the right-hand side guide and move it in the correct direction. Use the hand crank to adjust the position of the back jog until the paper just fits between the gate and the raised jog

fingers. If the standard fold gate returns early and causes a jam or double stitch, turn the gate timer clockwise enough to prevent the problem.

Without Optional Side/Corner Stitch Gate:

Corner stitching can be done with 5.5" x 8.5" or 8.5" x 11" (also: A4 or A5) paper. In all cases, mount one head in the far left position. The other head may be removed or left in any position without wire.

Two accessory guides must be mounted on the left hand side for corner stitching. First, adjust the standard left side guide as far as possible to the left. Using thumb screws and wing nuts, attach the corner stitch guide (9" long sheet metal part) to the two holes in the left side guide.

Next, lift open the top guard. Using two thumb screws, attach the corner stitch bar (11" long bar) to two holes in the table on the far left. The angle on the bar should face the front and middle of the machine. Adjust the left side guide until the corner stitch guide is aligned with the corner stitch bar.

Adjust the right side guide for paper length. For instance, if 8.5" x 11" paper is being corner stitched, the side guide must be set for the 11" length. Align the outer edge of the right side guide with the table scale as follows:

11" paper	11" mark
8.5" paper	6" mark
A4 paper	12.38" mark
A5 paper	6.54" mark

Adjust the stitching gate for paper width. For instance, for 8.5" x 11" paper, the gate must be set for the 8.5" width. First, lift open the front guard. Place a sheet on the table between the side guides, and slide it under the ski until it stops against the gate. Turn the knob until the trailing edge of the paper is just in front of the clinchers.

ADJUSTMENTS

GATE TIMER

The adjusting knob for the gate timer is located on the back of the machine's left side cover. It controls the amount of time that the stop gate is held down each cycle after the stitches have been driven into the booklet. Longer booklets need more time to get past the gate, and the next cycle cannot start until the gate has returned.

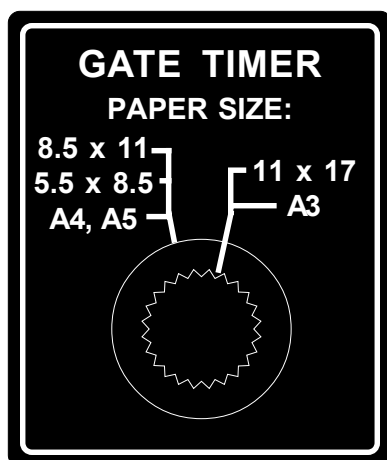

For 11" x 17" paper, set the knob as shown. The knob can be left in this position for any other paper size with feed rates up to 2,300 booklets per hour. For faster feed rates with smaller paper, turn the knob to the 8.5x11 position.

The stitch gate must be down long enough for booklet to pass over. If the gate comes up too soon, the gate limit switch could get tripped causing a double stitch. Turn the knob slightly clockwise.

If the stitch gate stays down longer than necessary and the feed rate is high, booklets will pass through the stitching station without getting stitched. Turn the knob slightly counter clockwise.

Once the adjustment is fine tuned, the knob can be calibrated by loosening its set screw and aligning the mark on the knob with the appropriate paper size.

BOOKLET SQUARENESS

Check the finished booklet. If the stitches are properly located on the fold, but the fold is off center, adjust the gates by turning the hand crank until sets will fold precisely in half.

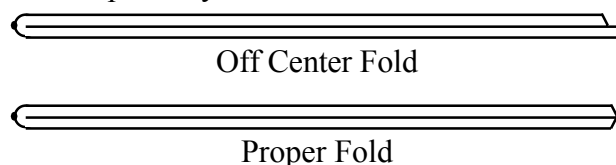

Important: Adjust the lock nuts as described below only as a last resort. First, carefully adjust the side guides and hand crank per page 8.

If the stitches are off the fold (see below), open the booklet flat and measure to see if the stitches are centered on the length of the paper. Turn the knob until stitches are placed precisely on the center of the paper. Next, remove the rear cover and locate the two lock nuts below the back end of the secondary table. Turn both nuts equally in small increments until booklets will fold precisely on the stitches.

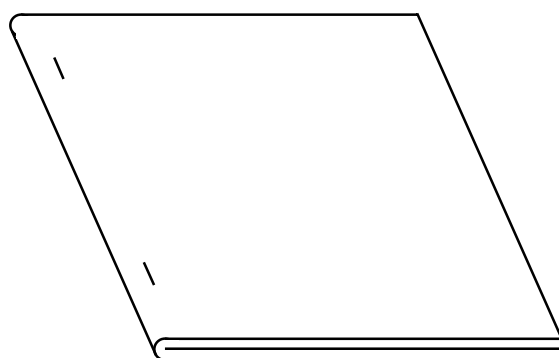

Finally, if the fold is not quite square (see below), the lock nuts can be adjusted individually.

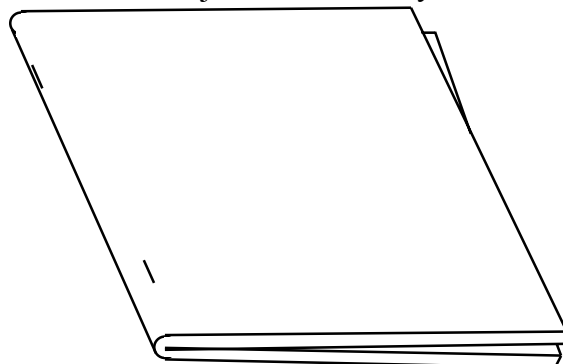

StitchFold

TROUBLE SHOOTING

PROBLEM:

SOLUTION:

1. Unit will not turn on.	<ol style="list-style-type: none">1. Plug unit into appropriate power supply.2. If there is no green light:<ol style="list-style-type: none">a. Check for proper line voltage. (115V or 220V)b. Check the "Main" fuse.c. Make sure front and top guards are closed.
2. Book remains in stitching position.	<ol style="list-style-type: none">1. Make sure motor and belt are running. If not, see problem 1.2. Check the "DC" fuse.3. Check the connection to the stitch gate microswitch (4LS).4. Turn to Stitch "off" position:<ol style="list-style-type: none">a. If stitch gate drops when putting a set through the machine, check connections to the stitch clutch.b. If stitch gate doesn't drop when putting a set through, check the stitch gate microswitch (4LS).
3. Book moves slowly through the machine.	<ol style="list-style-type: none">1. Make sure when feeding the book that it gets under the side guides.2. Spray furniture polish or wax on the entry and through the machine. Caution: Do not get polish or wax on paper drive belt.
4. Inconsistent fold.	<ol style="list-style-type: none">1. Use MBM Roller Wash (#0735) to clean all four folding rollers.2. Use MBM Roller Wash (#0735) to clean paper drive belt.3. Check and tighten the set screws in all five sprockets that drive the folding rollers. (Three on left side; two on right.)4. Make sure that the spring loaded folding rollers are freely springing out and back.5. Check the folding knife for bends or waviness. Straighten or replace the knife.
5. Stitches are not square to book.	<ol style="list-style-type: none">1. Make sure the stitch stops are square to the clinchers.2. Make sure the side guides are square to the stops.

PROBLEM:

SOLUTION:

<p>6. Stitch heads won't cycle.</p>	<p>1. Make sure that Stitch on/off switch is in "on" position.</p>
<p>7. Loud banging/clicking noise when stitch heads cycle.</p>	<p>1. Lubricate head per the "External Lubrication Sheet" provided with the stitch heads. (Lubrication instructions also appear in the <i>EZ Thread Owners Manual</i>.) Pay special attention to the rotator lubrication.</p>
<p>8. Double stitch.</p>	<p>1. Check stitch gate timer setting; see instructions on page 11. The gate should stay down until the tail end of the book clears the stitch gate. Otherwise, turn clockwise. 2. Check for sluggish operation of stitch gate. If there is binding or the return spring is too strong, the gate will fail to pull the stitch start limit switch, 4LS, away from the paper causing repeat stitching.</p>
<p>9. Booklet folded but not stitched.</p>	<p>1. Make sure that Stitch on/off switch is in "on" position. 2. Check that you are not feeding the books so fast that the gate has not come back up to receive the next book in time. In that case, adjust stitch gate timer setting per instructions on page 11.</p>



3134 Industry Dr. N. Charleston, SC 29418
1-800-223-2508 1-843-552-2700
Fax: 1-843-552-2974
www.mbmcorp.com

FORM QF96 6-9-05