

OPERATION MANUAL

MBM 207M MANUAL FOLDER

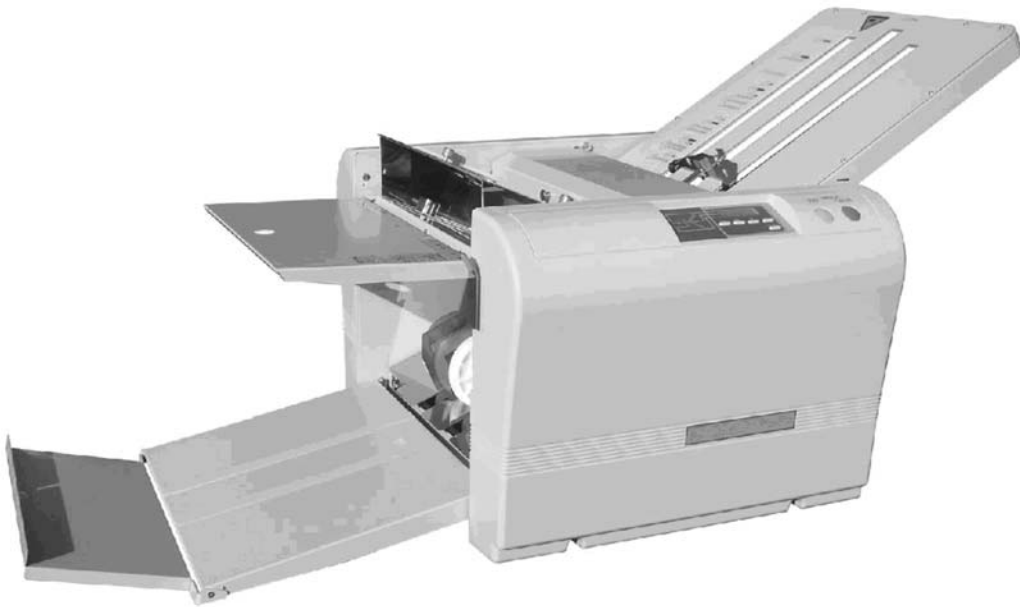

MBM
CORPORATION

1-800-223-2508
www.mbmcorp.com

Safety Instructions

Definition of Symbols and Notes

The following names and signs stand for possible dangers:



Danger

This symbol stands for immediate danger. Disregarding these instructions may cause severe injury.



Caution

This symbol stands for a potentially dangerous situation. Disregarding these instructions may lead to injuries or damage to property.

<h2>Danger</h2>	
	Make sure that the machine is electrically grounded to prevent electrical shock.
	Use the machine at 120 VAC with a frequency of 60Hz. There is a risk of electrical shock or fire if a higher or lower voltage is used, or if an electric current is utilized with a frequency not within the range stated above.
	Do not place any object on top of this machine. There is a risk of electrical shock or fire if water or any foreign object enters the machine.
	Handle the power cord with care. There is a risk of electrical shock or fire if the cord is damaged, broken, or placed under a heavy object.
	Do not insert or remove the power plug when water is present.
	Do not remove the cover of this machine. There is a risk of an electrical shock.
	Do not reconfigure the electronics of this machine. There is a risk of an electrical shock or fire.
	Do not operate the machine if it is emitting smoke or a strange odor. Turn off the machine, unplug from the outlet and contact your dealer.
	Do not operate the machine if the power cord is generating heat or emits a strange smell. Turn off the machine, unplug from the outlet and contact your dealer.
	If a foreign object enters into the machine, turn off the power switch and remove the power plug, then consult your dealer.
In the event of a thunderstorm, unplug the machine.	

<h2>Caution</h2>	
	Keep hair, clothing, and jewelry away from the machine while operating. Serious injury may result.
	Do not put the machine on an unstable or slanted surface. Doing so may cause the machine to drop or fall, causing damage and possible injury.
	Store and operate the machine in a clean, dust-free environment with low humidity. Avoid areas with high moisture, extreme temperatures and excessive dust, as these conditions may cause machine failure or electrical shock.
	Be sure to grasp the power cord by the plug when removing from the electrical outlet. Not doing so may cause damage to the cord and possible electrical shock or fire.
	Be sure to pull the power plug out of the electric outlet before moving the machine. Not doing so may cause damage to the cord and possible electrical shock or fire.
	Remove the power plug from the electrical outlet when this machine is not in use.

Introduction

Thank you for purchasing the MBM 207M Manual Paper Folder. You should receive many years of reliable service from this machine. Compact and easy to use, the 207M Paper Folder is sure to streamline your paper folding tasks, saving you valuable time. Please read the Operation Manual thoroughly before using this machine.

Contents





Introduction.....	3
Contents	3
(1) Specifications	4
(2) Accessories	5
(3) Description of Parts	6
(4) Designation and Functions of Operation Panel	7
(5) Preparations	8
(6) Operation Procedure.....	9
Switching the Power ON	9
Setting Fold Plate Position.....	9
Test Folding.....	9
Fold Feed Angle / Skew Adjustment.....	10
Continuous Folding.....	10
Subtraction Counting	10
Clearing a Paper Jam.....	11
Cross Folding	12
Fine Adjustments for Table 1	13
Fine Adjustments for Table 2	14
(7) Maintenance (Cleaning and replacement of consumable items).....	15
(8) Troubleshooting.....	17

(1) Specifications

Model	207M Manual Paper Folder
Paper size	3.5" × 5" to 11" × 17" Smaller size for single fold only.
Paper quality	High- to medium-quality paper
Fold type	Single, Letter, Zigzag, Double Parallel, and Fold-out. Cross-Fold.
Fold dimensions	Maximum Table 1: 13" Table 2: 9 1/2"
	Minimum Table 1: 2" Table 2: 1 1/2"
Paper feed system	Three-roller
Max. stacking capacity	500 sheets of 20# Bond
Folding speed	10,500 sheets/hr. (8.5 x 11, single fold)
Operation method	Digital keys
Available functions	Fold skew adjustment, paper jam detection, four digit counter, auxiliary paper guide for cross folding and Jam map indication.
Power consumption	109W
Additional functions:	Paper jam detector Four-digit counter with addition/subtraction modes Auxiliary paper guide for cross fold
Dimensions	W 29 1/2" × D 21 1/2" × H 21"(during use) W 22" × D 21 1/2" × H 21"(during storage)
Net weight	80 lb.

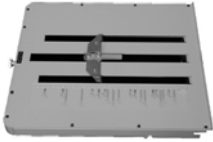
(2) Accessories

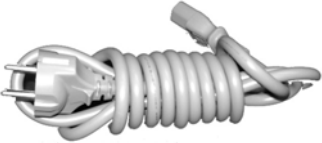
After un-boxing the 207M, make sure that the following accessories are present. Please contact your local dealer immediately if anything is missing.

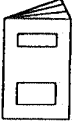
Accessories	Qty	
Table 1	1	
Table 2	1	
Power source cord	1	
Paper support guides (right and left)	2	
Machine cover	1	
Operation Manual	1	

(3) Description of Parts

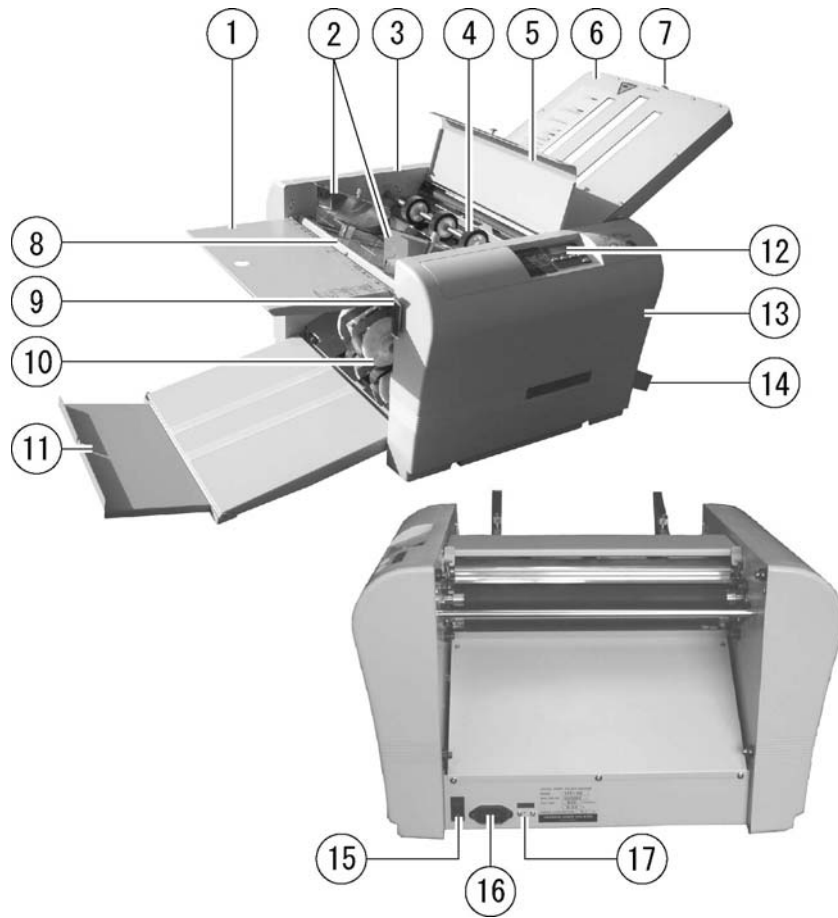

Stopper plate

Number	Name	Number	Name
1	Auxiliary feed table	10	Paper discharge roller
2	Paper guide	11	Paper stacking table
3	Left side cover	12	Control panel
4	Paper feed roller	13	Right side cover
5	Roller cover	14	Table 2
6	Table 1	15	Power source switch
7	Fold position adjustment knob	16	Inlet
8	Paper feed table	17	Circuit breaker
9	Paper feed table lever	18	

(4) Designation and Functions of Operation Panel

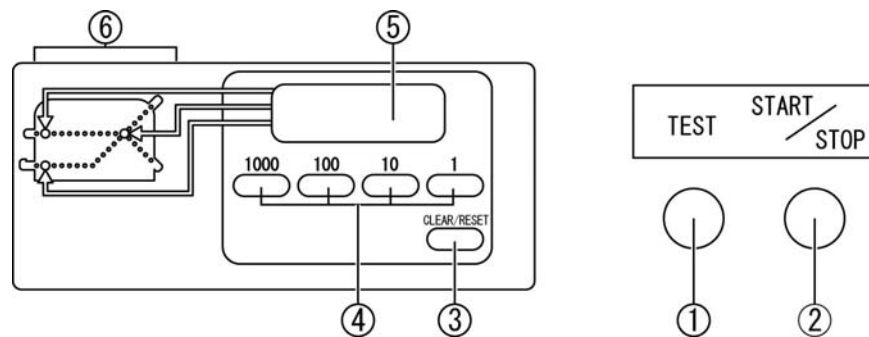

No.	Designation/Indication	Function
1	TEST key	Performs test folding of two sheets.
2	START/STOP key	Starts and stops machine.
3	CLEAR/RESET key	Clears the counter / resets after an error.
4	Numerical key	Used for Subtraction counting.
5	Counter	Indicates the number of sheets folded.
6	Check lamp	Comes on when paper stock is depleted, or indicates the location of a mis-feed.

(5) Preparation

Install Table 1 and 2:

Insert Table 1 on the studs indicated by (a) and (b) as shown in picture.

Insert Table 2 on the studs indicated by (c) and (d) as shown in picture.

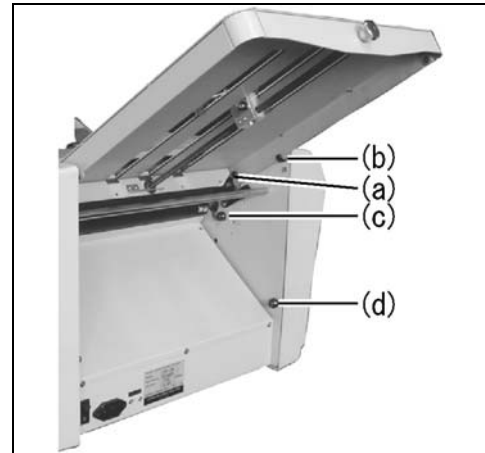

Note:

When setting Table 1, be sure to put its stopper plate at the center position.

Caution:

Be sure that both Table 1 and 2 fit correctly on the studs (a), (b), (c) and (d). If they are improperly set, it may cause an incorrect collation, or the tables may fall out of the machine.

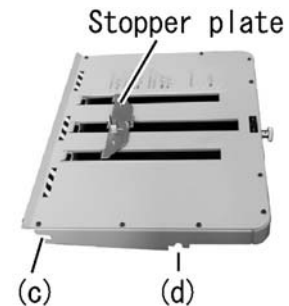

Setting Paper:

Lift the auxiliary table and insert the paper.

Raise the paper feed table lever.

Set the paper guide for the appropriate paper size.

Neatly stack the paper on the feed table with the printed side facing up. (printed side down in case of fold-out)

Lower the paper feed table lever.

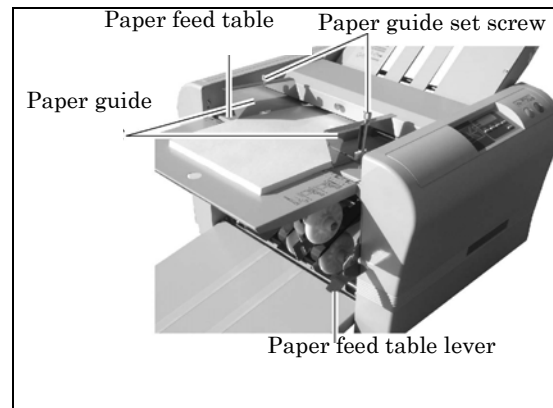

Note:

If the paper does not come in contact with the paper feed roller, remove and reinsert.

Curled or wrinkled paper may not feed correctly.

When using printed paper, insure that the ink is completely dry, otherwise marking may occur.

Setting the paper exit roller:

The exit roller should be moved to the proper position according to the paper size. Refer to the “Roller Position Indication” label. If ejection is not performed properly, try a different position.

Example:

Set the roller to position ONE when using 8 1/2” × 11” paper.

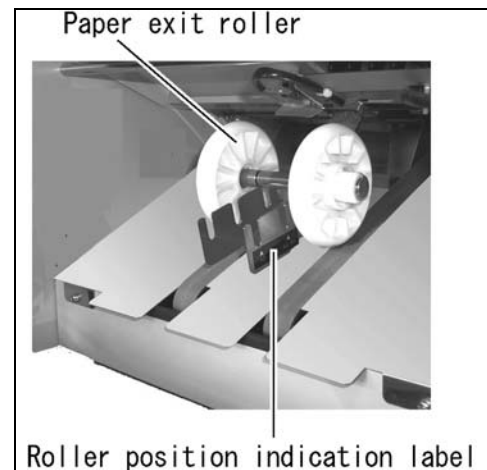

(6) Operation Procedure

Switch the Power to ON:

Insert power plug into a proper outlet.
Set the POWER switch to the ON position.

Note:

Remove the power plug from the outlet after use.

Setting Fold Plate Table Position

Pull the half-nut lever to move the stopper plate to the desired position on Table 1 and 2. Align the arrow on the stopper plate with the corresponding fold marks on the tables and release the half-nut. This locks the stopper plate into position.

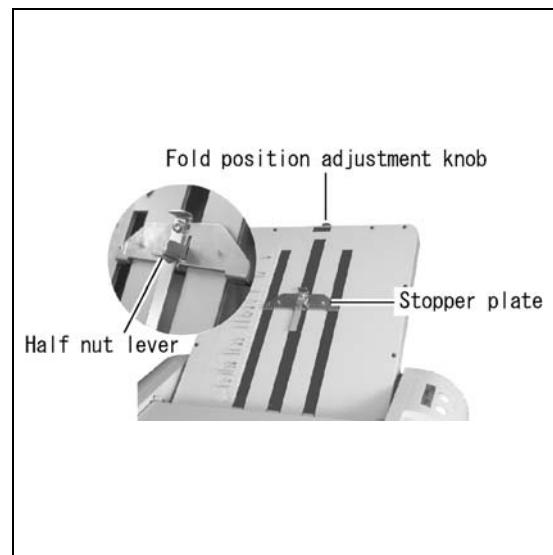

Test Folding:

Press the TEST key to feed two sheets of paper.
Check to see if the paper has been folded correctly by inspecting the second of the two folded sheets.

If the fold position is not correct, refer to “Fine Adjustments” on pages 13& 14

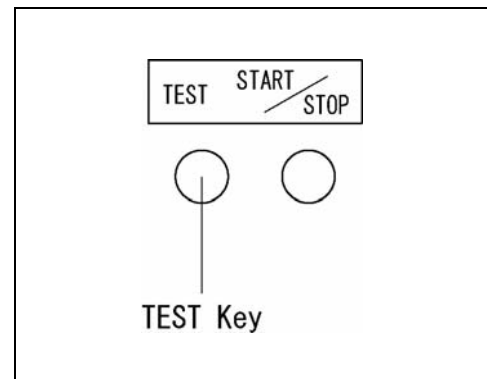

Fold Feed Angle / Skew Adjustment:

Turn the feed angle adjustment knob to the right if the lower side of the folded paper slants to the right.

Turn the knob to the left if the lower side slants to the left.

Note:

In cases other than single fold, put the folded paper face down on Table 1 to make a feed angle adjustment.

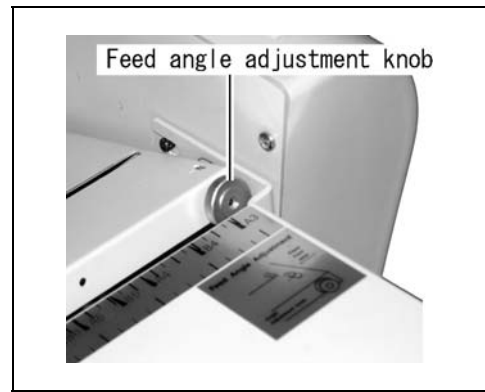

Continuous Folding:

Press the START/STOP key. The machine will fold the sheets continuously.

Press the START/STOP key again while the machine is in operation in order to stop feeding.

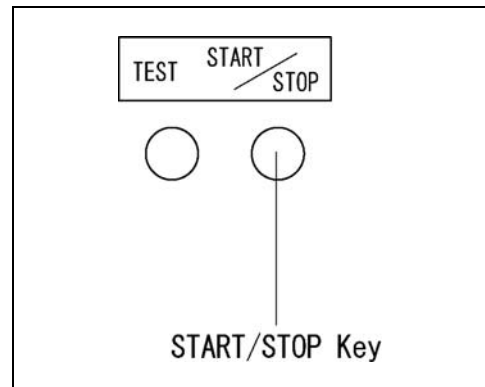

Subtraction Counting:

As each sheet is folded, the number indicated on the display decreases by one.

Press the appropriate numerical key to select the number of sheets to be folded.

Example:

Press the number “10” key twice to select 20.

Note:

The Subtraction counting number is cancelled when the POWER is set to OFF.

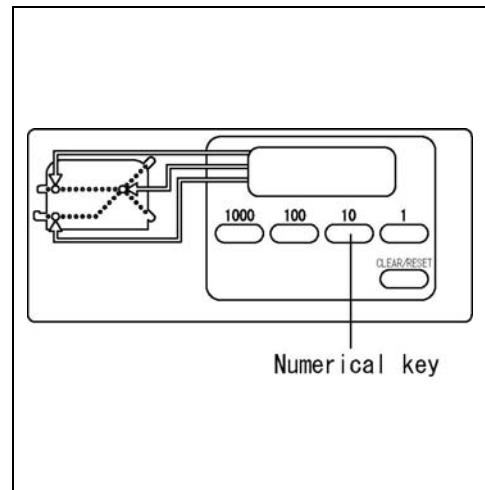

Under the following conditions the machine will automatically stop feeding:

(Press the CLEAR/RESET key to reset after an error has been corrected)

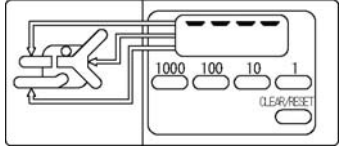
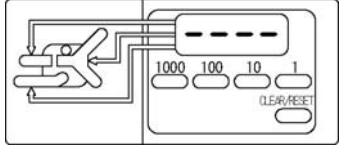
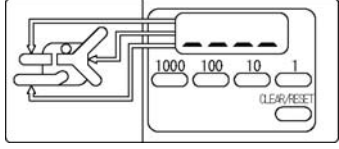
Conditions	Indication on Control panel
<p>When the START/STOP key is pressed when there is no stock.</p> <p>When the START/STOP key is pressed while the paper feed lever is in the up position.</p> <p>When stock runs out while folding in the Subtraction Counting Mode.</p>	
<p>When a mis-feed occurs.</p> <p>When paper jam occurs at Table 1 and Table 2.</p> <p>When Roller cover is opened.</p>	
<p>When paper stack (exit) table is full.</p> <p>When paper jam occurs at the paper exit.</p>	

Clearing a Paper Jam:

Should a paper jam occur, set the POWER switch to the OFF position and remove the jammed sheet(s). When the jammed paper is wrapped around the fold roller or other parts, it can be easily removed by detaching Tables 1 and 2 from the unit.

Note:

When the roller cover is opened, the machine will automatically stop operation.

Cross Folding:

Cross folding refers to performing the double parallel, letter, or other types of folds on single-folded sheets of paper.

Example:

11" × 17" sheet is folded in half, and then cross-folded to letter size to fit into a standard # 10 envelope.

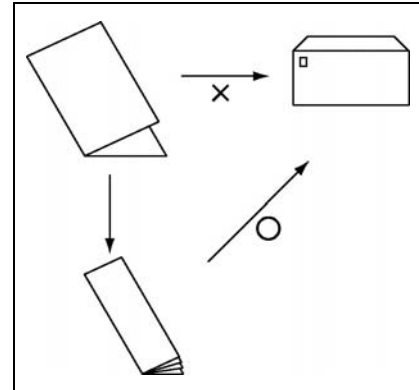

Note:

The maximum weight of paper that can be used for cross folding is 28#.

However, the following variables may affect performance of the paper stock being folded: paper type, paper size, grain direction, printing quality, as well as the relative humidity and temperature of the operating environment.

On occasion, fold displacement may occur, causing a corner of the folded paper to be folded inside as indicated in the figure at the right. In these cases, additional fine adjustment may need to be made to the fold tables to eliminate the problem.

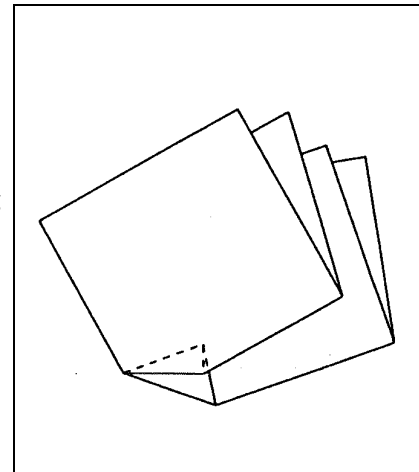





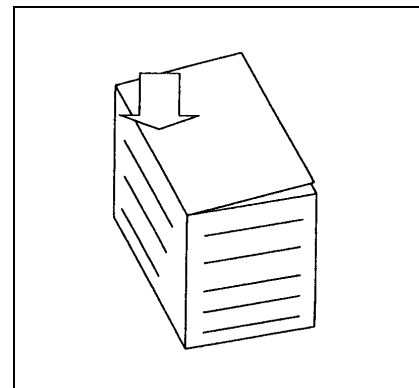









Tip:





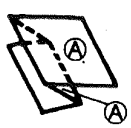





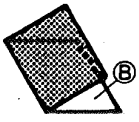

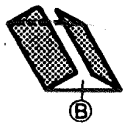

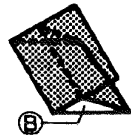
To aid in the cross-folding procedure, press the crease of the single-folded stock flat before attempting to cross fold.

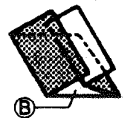

Fine Adjustments for Table 1

Fold type		Plane (A)	Direction to turn the Table 1 fine adjustment knob
Single fold	Table 1 is not used		
Gate fold		Long	
		Short	
Letter fold		Long	
		Short	
Zigzag fold		Long	
		Short	
Double parallel fold		Long	
		Short	
Fold-out Fold		Long	
		Short	

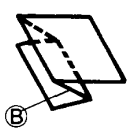
Fine Adjustments for Table 2

Fold type		Plane (B)	Direction to turn the Table 2 fine adjustment knob
Single fold		Long	
		Short	
Gate fold		Long	
		Short	
Letter fold		Long	
		Short	
Zigzag fold		Long	
		Short	
Double parallel fold		Long	
		Short	
Fold-out fold		Long	
		Short	

(7) Maintenance

- Keep roller cover closed to prevent dust from accumulating on the rollers.
- Clean the rollers regularly using a cleaner suitable for rubber rollers or a cloth slightly dampened with water. Do not use solvents or aerosol sprays.
- If paper dust or ink accumulates on the paper rollers or separator, the paper feeding function will deteriorate and may cause a paper jam or slipping. If this happens, clean them using a cleaner suitable for rubber rollers or a cloth slightly dampened with water. Do not use solvents or aerosol sprays.
- Remove any dirt on the exterior parts using alcohol or appropriate cleaner. Do not use solvents.

Two rollers can be removed and installed without using tools. These two can be easily cleaned along with the paper ejection photo sensor.

As the other two rollers cannot be removed easily, they should be cleaned while slowly revolving them by hand.

If only one sheet of paper is being fed, use a soft cotton swab to remove paper dust, etc. from the face of the paper ejection photo sensor shown by the arrow.

(1) Removing the rollers

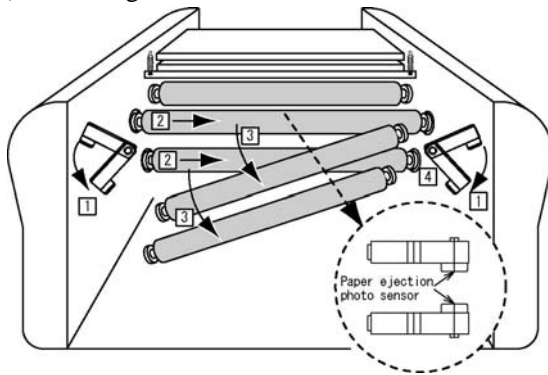

Remove the upper roller in the order of **1** to **3**, and then remove the lower roller.

1 Move down the roller setting lever to the OFF position.

2 Slide the roller to the right.
(Its shaft will come off from the left-side hole.)

3 Remove the roller from the right-side hole.

(2) Setting of the rollers

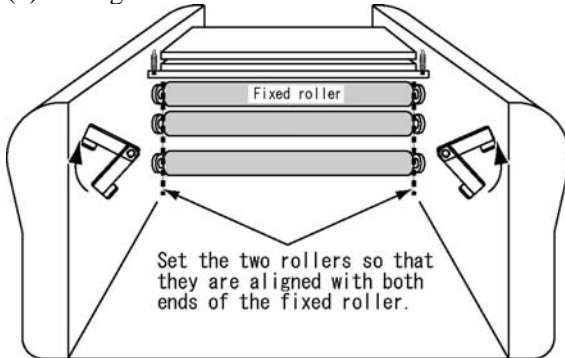

In the reverse order of removal, set the lower roller first.

[1] Insert the roller deep to the right.

[2] Slide the roller to the left.

* Be careful not to let the roller shaft on both sides get stuck on Part A.

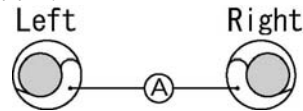

As shown above, the roller shaft should be placed on Part A.

[3] Move up the roller setting lever to the ON position.

Caution!

If the roller is not firmly fixed, it may cause operating problems.
If it cannot be fixed, contact your dealer.



Paper ejection photo paper

Replacing Paper Separator, Paper Feed Roller & Brake Rubber

When replacing the paper feed roller and paper separator, proceed in the order of (1) to (2).

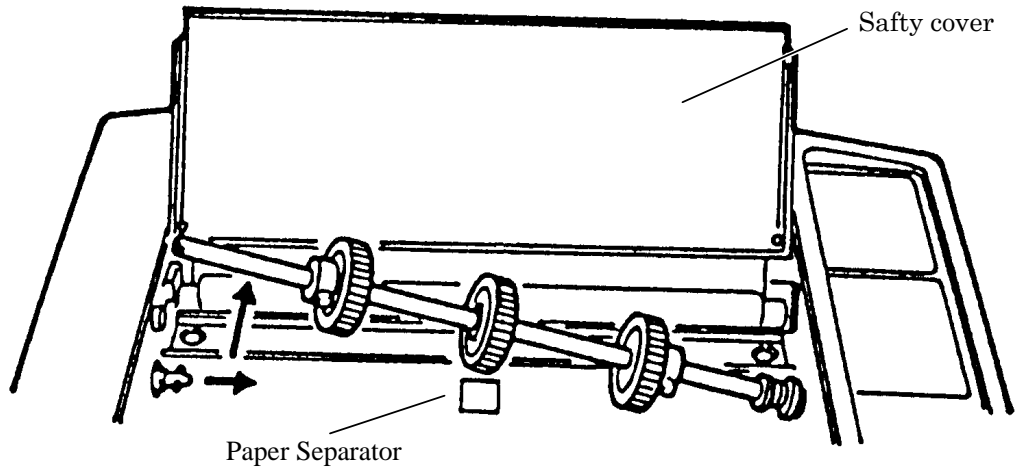

Grasp the paper separator (with plastic part) at both ends and pull it out.
To install, reverse the procedure.

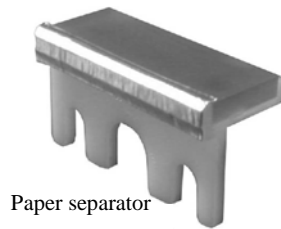

To order the parts above, please contact your dealer.

(8) Troubleshooting

Trouble	Possible Cause	Measures
The paper does not feed properly	Recently printed paper sticks together	Jog the paper sufficiently. Make sure that the ink is dry.
	Stains on the paper separator	Clean the paper feed separator using appropriate cleaner.
	Stains on the paper feed rubber roller	Clean the dust or ink on the paper feed roller using appropriate cleaner.
	The paper separator is worn out	Install a new paper separator.
	The volume of the paper stacked on the paper feed table is not enough	Add more paper to the feed table – at least 20 sheets or more.
The machine does not operate even after the START/STOP key is pressed	Paper jam inside the unit	Detach Table 1 and 2 and remove the jammed paper from the unit.
Wrinkles appear on the paper	Recently printed paper sticks together	Jog the paper sufficiently. Make sure that the ink is dry.
	Stains on the paper separator	Clean the paper separator using an appropriate cleaner.
	Stains on the paper feed roller	Clean the dust or ink on the paper feed roller using an appropriate cleaner.
	Stains on paper fold rollers	Clean all four fold rollers using an appropriate cleaner.
	Tables 1 and 2 are not properly set	Reset properly.
	Paper jam in Table 1 and 2	Detach Table 1 and 2 and remove the jammed paper.
Improper fold position	The length of the paper is not standard size	Measure the length of the paper and adjust using the fine adjustment knob.
Printed paper (13# or lighter) cannot be folded	The surfaces of the fold rollers are covered with dust or ink, causing them to be slippery	Clean all four fold rollers using an appropriate cleaner.
	Low room temperature	Operate the machine in a climate-controlled environment. Paper should be at room temperature before folding. Paper stored below 53F is not recommended.

MBM Corporation